

ABUNDACULTURE

Formerly: The Noah Project

SOLAR ELECTRICITY

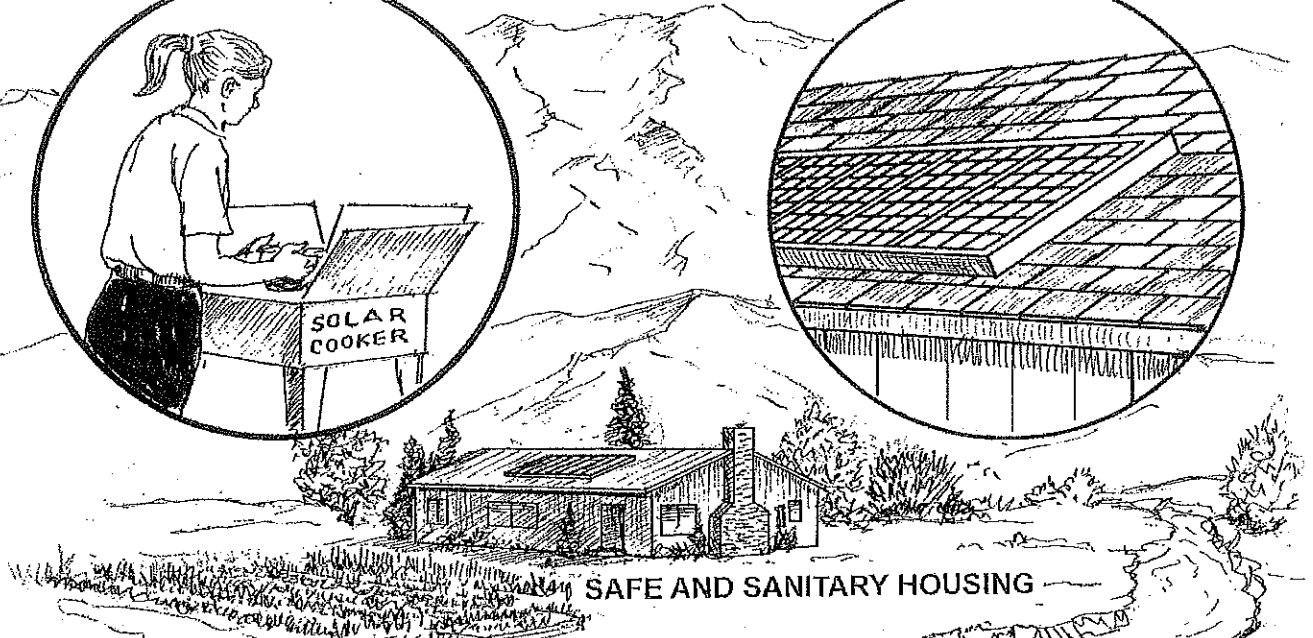
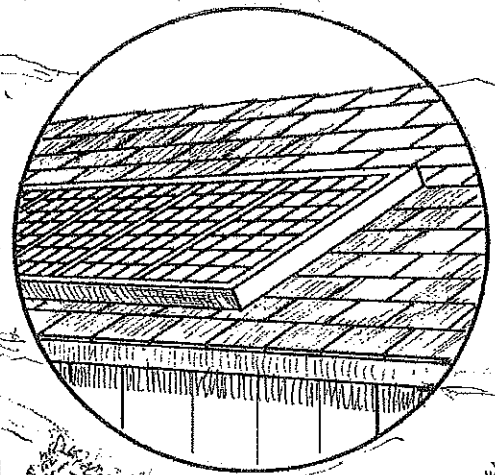
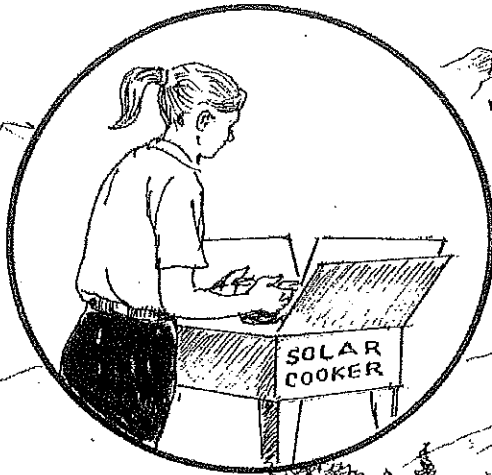

SAFE AND SANITARY HOUSING

GOOD FOOD

CLEAN WATER



PATHWAYS TO GOD'S ABUNDANCE

By Jack Dody

ABUNDACULTURE

Forward

Jack Dody and Dwight Gradin
Marilou Dody, editor

“Oh, Lord, my God, when I, in awesome wonder, consider
all the worlds thy hands have made”

How Great Thou Art – Boberg

These words from the great Christian hymn attempt to describe the glory and power of the King of the Universe, the Creator of all things. He created a world overflowing with all of the things needed for a life of plenty. There is potentially more food than we need. Exactly the same amount of life-giving water flows on the planet as existed in the days immediately following creation. Resources for building homes are found everywhere, and the energy available on the earth far surpasses our needs. The Bible contains instructions regarding the stewardship of God's creation which, if followed, would place our feet on the path to abundance.

But something is terribly wrong. More than a billion people on this planet are starving. Billions live in hovels surrounded by filth. Approximately two million people will die this year because they do not have access to clean water (United Nations, *Beyond Security*, executive summary, 2006). As individuals, we often do not follow God's instructions, and corrupt governments often neglect and abuse the people they rule. How can this be?

As we read the story of the Israelites, we see that God clearly states the conditions for experiencing abundance. Notice God's promises:

Leviticus 26:3-5 If you follow My decrees and are careful to obey my commands, I will send you rain in its season, and the ground will yield its crops and the trees of the field their fruit. Your threshing will continue until grape harvest, and the grape harvest will continue until planting, and you will eat all the food you want and live in safety in your land.

However, we see that even the Chosen People couldn't live up to God's requirements for the abundant life. They sinned, and, as a result, did not experience the abundance that was promised. But God reached out to them to deliver them from their sins.

Isaiah 1:18 “Come now, let us reason together,” says the Lord. “Though your sins are like scarlet, they shall be a white as snow; though they are red as crimson, they shall be like wool.”

God offered to restore the abundance of the Israelites, but it was conditional, as the next sentence indicates.

Isaiah 1:19-20 If you are willing and obedient, you will eat the best from the land, but if you resist and rebel, you will be devoured by the sword.”
For the mouth of the Lord has spoken.

The people of Israel were rebellious. They were not willing to follow God's words. They were not obedient. And, as a general rule, they did not enjoy abundance. It should also be noted that acts of disobedience have a direct effect on all of creation.

Isaiah 24:4,5 The earth dries up and withers, the world languishes and withers, the exalted of the earth languish. The earth is defiled by its people; they have disobeyed the laws, violated the statutes and broken the everlasting covenant.

Romans 8:19-22 The creation waits in eager expectation for the sons of God to be revealed. For the creation was subjected to frustration, not by its own choice, but by the will of the One who subjected it, in hope that the creation itself will be liberated from its bondage to decay and brought into glorious freedom of the children of God . We know that the whole creation has been groaning as in the pains of childbirth right up to the present time.

As a follower of Jesus, I believe that men are not capable of following the Law of Moses. Sinful men cannot enjoy abundance because we cannot obey the commands of God. But God, in His mercy, sent Jesus to save us from sin. With the help of the Holy Spirit, we can have faith in Jesus and learn to follow God's instructions which lead to abundance. Without Jesus, we can have no true, lasting abundance! Of course, we can only follow God imperfectly until we are with Him in heaven, but through Jesus our imperfections are covered by grace. Thus, abundance is a gift from God, and He is the source of all good things. See how abundance is expressed in Psalm 65: 9-13:

You (God) care for the land and water it; you enrich it abundantly.
The streams of God are filled with water to provide the people with grain,
for so you have ordained it.
You drench its furrows and level its ridges;
You soften it with showers and bless its crops.
You crown the year with your bounty, and your carts overflow with
abundance.
The grasslands of the desert overflow;
the hills are clothed with gladness.
The meadows are covered with flocks and the valleys are mantled with
grain; they shout for joy and sing. [my underlining]

Many would argue that, in fact, evil men often do enjoy abundance, while many righteous men live in poverty. Therefore they dismiss the idea that abundance comes from our Father in heaven. It is true that God does not provide abundance to all believers at all times. Sometimes He uses hardship to build our characters and test our faith. A good example is the story of Job. But if one looks at all of history, it is apparent that those people who consistently base their lives on biblical principles prosper far more than those who do not. Remember, after Job was tested, he was restored to abundance.

To bring clarity to the subject of abundance, we need to understand fully what the Bible says about the subject.

Biblical Principles Concerning Abundance

PRINCIPLE ONE: Abundance is a manifestation of God's character and a part of God's creation.

I define abundance as "more than enough." Abundance shows God's majesty, creativity, and generosity toward His people, and His affection for them. Any gardener or farmer can tell you that plants produce an abundant number of seeds. More than enough plants can spring from the seeds that God provides on each plant. Left untouched by man, most landscapes will soon be overgrown by plants and over-run by insects and animals if God provides enough rain.

PRINCIPLE TWO: God commissioned men to take care of the garden. We are stewards of God's creation and He holds us responsible.

A patch of land that is overgrown by weeds and over-run by vermin is not very useful. Abundance comes about when men take seriously and act upon the biblical directive to "take care of the garden."

Genesis 1:28 God blessed them and said to them, "Be fruitful and increase in number; fill the earth and subdue it. Rule over the fish of the sea and the birds of the air and over every living creature that moves on the ground."

Genesis 2:15 The Lord God took the man and put him in the Garden of Eden to work it and take care of it.

Because of the Fall, God cursed the ground, and taking care of the garden became fraught with “painful toil.” Abundance only occurs now by sweat and toil; but still occurs by God’s gracious provision.

Genesis 3:17b Cursed is the ground because of you. . . .

Proverbs 28:19 He who works his land will have abundant food, but the one who chases fantasies will have his fill of poverty.

PRINCIPLE THREE: God provides everything needed for abundance.

Genesis 1:29 Then God said, “I give you every seed-bearing plant on the face of the whole earth and every tree that has fruit with seed in it”

Genesis 9:3 Everything that lives and moves will be food for you. Just as I [God] gave you the green plants, I now give you everything.

Note: There are many things inherent in the design of the universe that make abundance possible: nutrients, processes, cycles, even gravity. A thoughtful study of photosynthesis points to a Creator worthy of worship.

PRINCIPLE FOUR: God designed cycles and processes so that abundance would always be available to man.

Even though men are basically sinful beings—greedy, selfish, lazy and foolish—God’s created order remains. Abundance is still possible because God’s plans will not be thwarted by men. Creation points to a marvelous Creator. The more we know, the more we can appreciate the greatness of our God. He is not a figment of our imagination. He is real. And He’s not far off. He is near. We can communicate with Him and know Him.

True science is the study of God’s creation. An important component of taking care of God’s creation is the study of the creativity and intelligence of His designs. The following illustrations are just a few of hundreds of cycles and processes that directly affect God’s abundant provision.

Look at God's design and created order. He put the world in place.

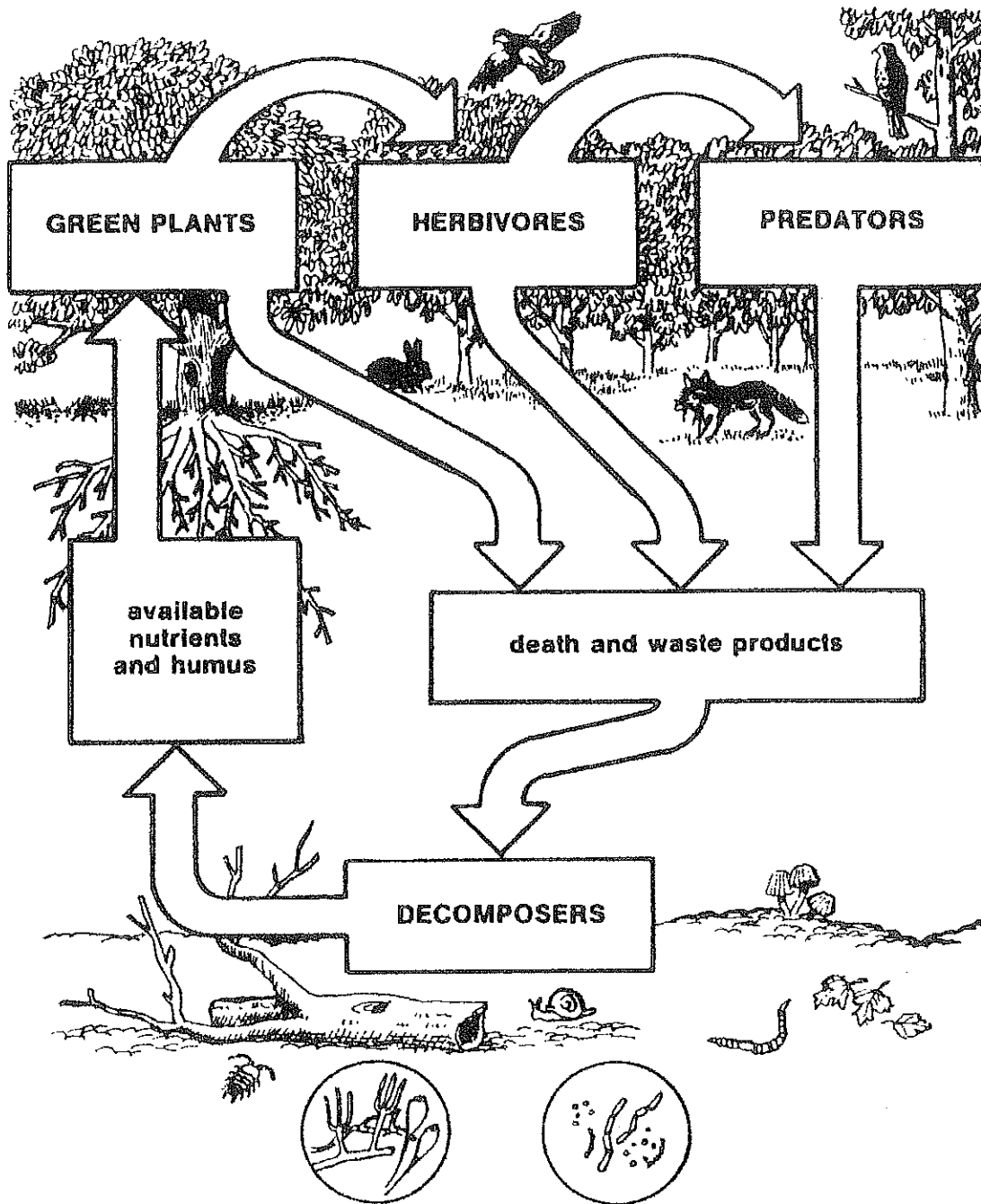

In the forest, nutrients are recycled through the natural decomposition of plant and animal waste.

Illustration from THE RODALE BOOK OF COMPOSTING, 1992

See how God has designed all natural processes! The path to abundance is in understanding these processes and cooperating with God's designs.

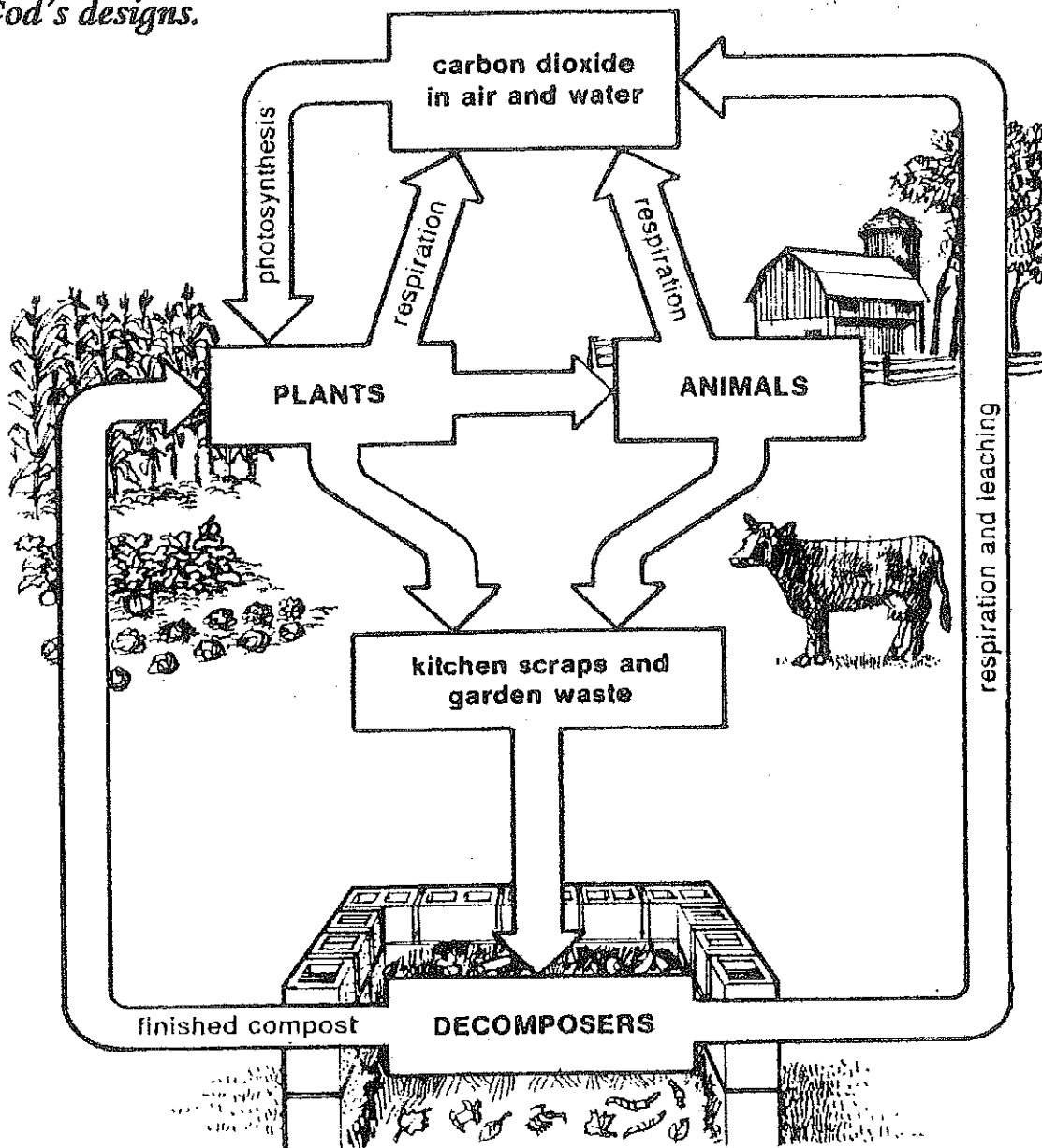

The carbon cycle. Green plants use carbon dioxide gas, water, and sunlight to make sugars and other carbon-containing compounds that animals use as food. Carbon compounds in plant and animal wastes provide food for decomposers in the compost pile. Materials that have passed through the decomposers' bodies and the microbial bodies themselves contain nutrients used by plants to continue the carbon cycle.

Illustration from THE RODALE BOOK OF COMPOSTING, 1992

These cycles and processes are God's doing – they didn't just happen. God's wisdom and creativity should cause us to worship and praise Him.

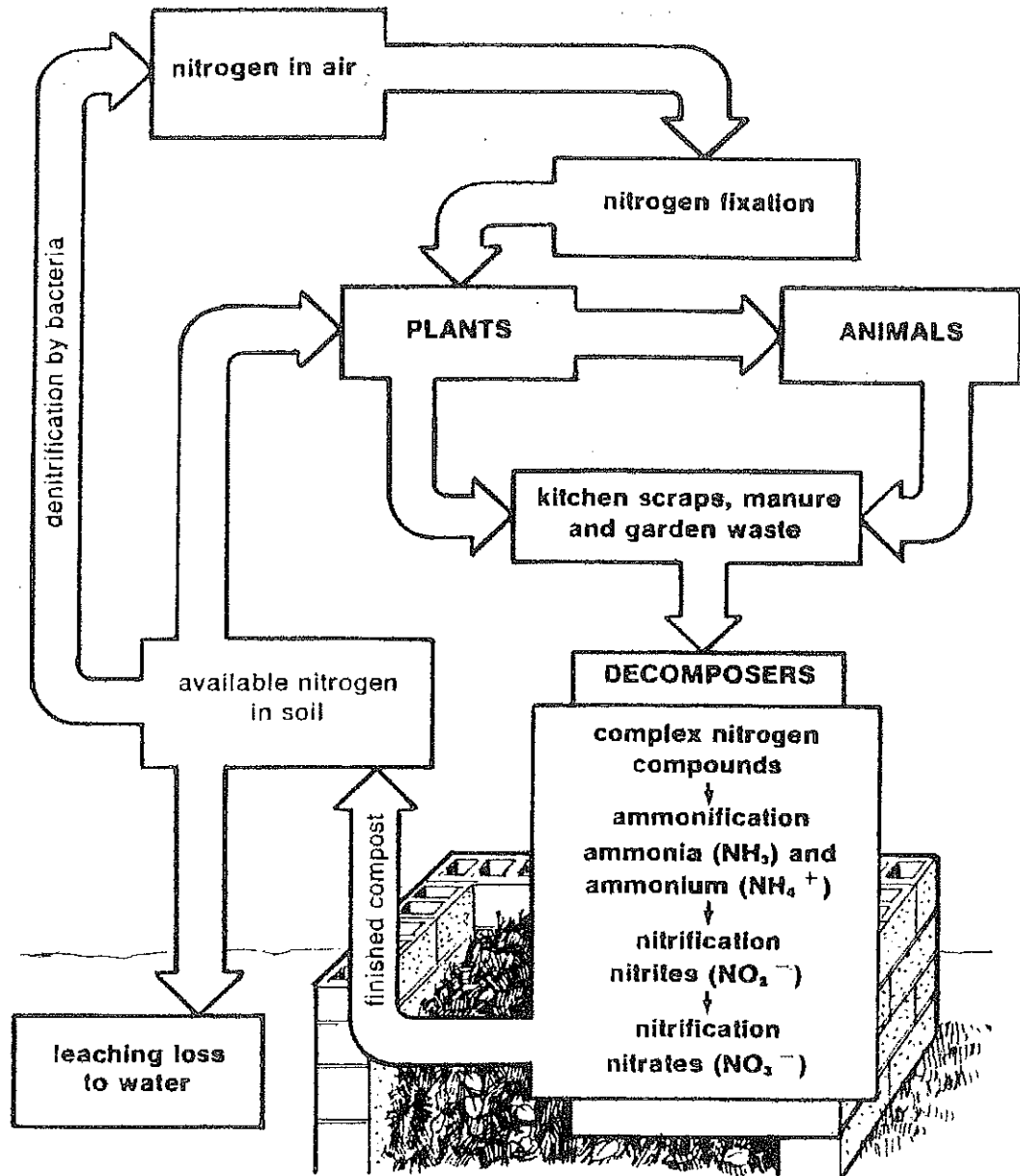

The nitrogen cycle. Shortage of available nitrogen is often a limiting factor in plant growth, since plants can't make use of abundant atmospheric nitrogen gas. (So-called nitrogen-fixing plants rely on symbiotic bacteria.) Composting plant and animal wastes exposes the nitrogen they contain to nitrogen-fixing microorganisms and decomposers that break it down into forms available to plants.

Illustration from THE RODALE BOOK OF COMPOSTING, 1992

The Hydrologic Cycle

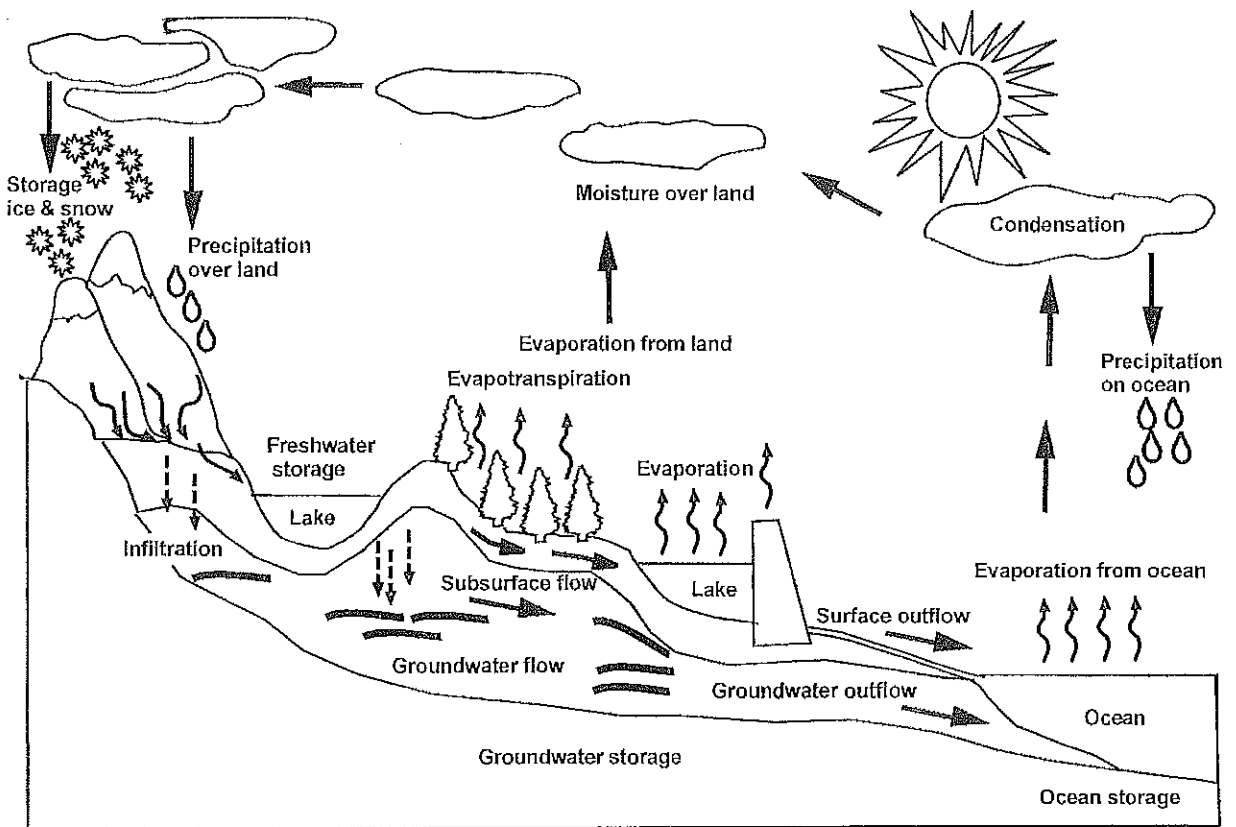

Job 36: 27+28 He [God] draws up the drops of water, which distill as rain to the streams; the clouds pour down their moisture and abundant showers fall on mankind.

Illustration by Don Childers

PRINCIPLE FIVE: God expects His people to share their abundance. The abundance we experience will be in direct proportion to our generosity.

Proverbs 11:24,25 One man gives freely, yet gains even more; another withholds unduly, but comes to poverty. A generous man will prosper; he who refreshes others will himself be refreshed.

Luke 6:38 [Jesus speaking] Give, and it will be given to you. A good measure, pressed down shaken together and running over, will be poured into your lap. For with the measure you use, it will be measured to you.

II Corinthians 9:6 Remember this: whoever sows sparingly will also reap sparingly . . .

II Corinthians 8:13-15 Our desire is not that others might be relieved while you are hard-pressed, but that there might be equality. At the present time your plenty will supply what they need, so that in turn their plenty will supply what you need. Then there will be equality, as it is written, "He who gathered much did not have too much, and he who gathered little did not have too little."

When God's people have experienced more than enough, we are to share with others. We are to share our knowledge of, and our love for, the Creator God. And we are to share the products of His blessings. In gratitude we express how great our creator is and how the intricacies of creation manifest a God who we can get to know through Jesus, who is Emmanuel, God with us.

PRINCIPLE SIX: God, through His Word, provides wisdom and guidance that leads to abundance.

Using the wisdom provided by God in His Word, and knowledge gained by careful study of creation, a servant of God can successfully "take care of the garden" and produce abundant, useful crops that are not over-run by destructive pests.

Psalms 111:10 The fear of the Lord is the beginning of wisdom; all who follow his precepts have good understanding.

Deuteronomy 8:18 But remember the Lord your God, for it is He who gives you the ability to produce wealth, and so confirms His covenant, which He swore to your forefathers, as it is today.

Proverbs 10:22 The blessing of the Lord brings wealth, and He adds no trouble to it.

II Timothy 3:16,17 All scripture is God-breathed and is useful for teaching, rebuking, correcting and training in righteousness, so that the man of God may be thoroughly equipped for every good work. [my underlining]

PRINCIPLE SEVEN: Only God will, in His time, restore the earth to its full glory. We are to be faithful stewards, working toward restoration until He returns.

Colossians 1:15-20 He [Jesus] is the image of the invisible God, the firstborn over all the creation. For by Him all things were created: things in heaven and on earth, visible and invisible, whether thrones or powers or rulers or authorities; all things were created by Him and for Him. He is before all things, and in Him all things hold together. And He is the head of the body, the church; He is the beginning and the firstborn from among the dead, so that in everything He might have the supremacy. For God was pleased to have all His fullness dwell in Him, and through Him to reconcile to Himself all things, whether things on earth or things in heaven, by making peace through His blood shed on the cross. [underlining mine]

Psalms 104:24-30 How many are Your works, O Lord! In wisdom You made them all; the earth is full of Your creatures. There is the sea, vast and spacious, teeming with creatures beyond number—living things both large and small. There the ships go to and fro, and the leviathan, which You formed to frolic there. These all look to You to give them their food at the proper time. When You give it to them, they gather it up; when You open Your hand, they are satisfied with good things. When You hide Your face, they are terrified; when You take away their breath, they die and return to dust. When You send Your Spirit, they are created, and You renew the face of the earth. [underlining mine]

Revelation 22:1-5 Then the angel showed me the river of the water of life, as clear as crystal, flowing from the throne of God and of the Lamb down the middle of the great street of the city. On each side of the river stood the tree of life, bearing twelve crops of fruit, yielding its fruit every month. And the leaves of the tree are for the healing of the nations. No longer will there be any curse. The throne of God and of the Lamb will be in the city, and His servants will serve Him. They will see His face, and His name will be on their foreheads. There will be no more night. They will not need the light of a lamp or the light of the sun, for the Lord God will give them light. And they will reign for ever and ever. [underlining mine]

Note: I don't know if God makes a "new heaven and earth" from the old one, or if He creates, from nothing, a new heaven and earth. Only He is capable of creating a new heaven and earth, regardless of how He does it.

Conclusion

“Then sings my soul, my savior God to thee: How great Thou art!
How great Thou art!”

How Great Thou Art – Boberg

True abundance occurs when God's people, in obedience and dependence on Him, take care of His creation with wisdom and diligence and are blessed with more than enough, enabling them to share with others and to bring glory to the creator God. Without faith in Jesus, the Creator of the universe, and help from the Holy Spirit, it is impossible to understand and implement God's directives that lead to abundance.

ABUNDACULTURE™

Abundaculture™ is a word coined to describe God's pathway to abundance. Abundaculture™ is an integrated system that allows a child of God, in dependence upon the Holy Spirit, to access God's abundance in providing energy, housing, clean water, good food, and sanitary living conditions for himself and to share with others.

Abundaculture™ does not advocate self-sufficiency or sustainability. God directs His people to depend upon Him and upon each other. We embrace God's all-sufficiency. "He is our source of everything and in Him we find increase." (from *Farming God's Way*)

Abundaculture™ is an amalgamation of ideas collected over four decades. Due credit is given to the following pioneers:

Brad Oldreive – *Farming God's Way*
Don Richards – *Environment and Resource Stewardship*
Michael Reynolds – *Earthships*
Brad Lancaster – *Rainwater Harvesting*
Bill Mollison – *Permaculture*

...and to those homesteaders who search for a better way and who are willing to share their ideas.

Throughout this training manual you will find Steps on the Pathway to Abundance. Use these steps in your quest for God's abundance in your life.

STEPS ON THE PATHWAY TO ABUNDANCE

Use the following as a checklist on your journey to abundance:

GENERAL INFORMATION

- First and foremost, acknowledge Jesus as God and Savior. Acknowledge your dependence upon Him. Without faith in the Creator of the universe, and help from the Holy Spirit, it is impossible to understand and implement God's directives that lead to abundance. Without faith in Christ, true abundance is not possible.
- Constantly renew the mind by studying God's Word and His creation. Ask God for wisdom.

Psalm 111:10 The fear of the Lord is the beginning of wisdom; all who follow His precepts have good understanding.

II Timothy 3:16,17 All Scripture is God-breathed and is useful for teaching, rebuking, correcting and training in righteousness, so that the man of God may be thoroughly equipped for every good work.

- Conserve resources, including human energy. Realize that all resources are a gift from God and must be handled with care.
- Increase productivity with careful, diligent work. Plant on time. Harvest on time. Prepare for the future.

Proverbs 28:19 He who works his land will have abundant food, but the one who chases fantasies will have his fill of poverty.

II Thessalonians 3:10 If a man will not work he shall not eat.

Study God's creation and cooperate with God's natural cycles:

- The Carbon Cycle
- The Hydrological Cycle
- The Hydrogen Cycle
- The Nitrogen Cycle

Establish and protect property rights. If your property (including land) can be confiscated, it is very difficult to create generational abundance.

Numbers 26:52-53a *The Lord said to Moses, "The land [the promised land] is to be allotted to them [the Israelites] as an inheritance...."*

Numbers 27:1-11 Note the importance placed on the ownership of land. It is part of God's commandments to Moses.

Zechariah 3:9-10 *"...and I [God] will remove the sin of this land in a single day. In that day each of you will invite his neighbor to sit under his vine and fig tree," declare the Lord Almighty.*

(God's plan is for His people to have private ownership of their property.)

(A more detailed study of God's thoughts on land ownership can be found in Leviticus 25:10, 13-14, 23-34.)

Strive for excellence. Excellent work leads to abundance.

Colossians 3:23-24 *Whatever you do, work at it with all your heart, as working for the Lord, not for man, since you know that you will receive an inheritance from the Lord as a reward. It is the Lord Christ you are serving.*

II Corinthians 9:6 *Remember this: whoever sows sparingly will also reap sparingly....*

II Corinthians 9:8 *And God is able to make all grace abound to you, so that in all things at all times, having all that you need, you will abound in every good work.*

Share abundance and teach others the pathways to abundance.

Matthew 25:34-36 [Jesus speaking] Then the King will say to those on His right, "Come, you who are blessed by My Father; take your inheritance, the kingdom prepared for you since the creation of the world. For I was hungry and you gave Me something to eat, I was thirsty and you gave Me something to drink, I was a stranger and you invited Me in, I needed clothes and you clothed Me, I was sick and you looked after Me, I was in prison and you came to visit Me.

Luke 6:38 [Jesus speaking] Give, and it will be given to you. A good measure, pressed down, shaken together and running over, will be poured into your lap. For with the measure you use, it will be measured to you.

Start at home, today! Don't wait for the government or anyone else. Do it yourself with God's help.

APPROPRIATE TECHNOLOGY

What is Appropriate Technology?

Appropriate Technology is a way to solve problems on the mission field using methods and materials that are:

Available

Affordable

Acceptable

SOLAR ARK is a name we have coined for the homes we design. SOLAR ARKS use passive solar design, renewable energy such as photovoltaics and biomass, roof water catchment systems and cisterns, high intensity gardens and composting toilets.

Jack Dody has been developing Appropriate Technology for more than 35 years. He has trained missionaries serving in more than 100 countries. He and his wife live in an off-the-grid home that employs many of the Appropriate Technologies which he shares with his students. The writings and training manuals developed by Jack are available on-line at no charge at *christianhomesteaders.org*.

Due to variability of local conditions, materials, skills, site and so forth, the author can assume no responsibility for personal injury, property damage, or loss from actions inspired by information in this workbook. You are responsible for consulting with experts, engineers and code enforcement people whenever prudent.

Unless otherwise noted, all Scripture references are taken from The New international Version © 1984.

Mission Statement

The purpose of our ministry is to help missionaries, homesteaders and homeschoolers succeed. Through education and example, we show missionaries how they can meet their own physical needs and the needs of the people they serve, no matter how difficult their circumstances.

We help develop strategies for safe, comfortable living space with dependable electricity, clean water, good food and sanitary waste disposal.

Whether you serve in the heart of the city or in rural areas, we help you create appropriate technologies for your family and for the people you will reach for Christ.

We help you answer two important questions:

1. How can you function effectively even in very difficult living conditions?
2. How can you use appropriate technology strategies to gain opportunities to share the love of Jesus.

THE BASIC PREMISES

1. Every person longs for a safe, comfortable place to live, with clean water, good food and functional sanitation.
2. God provides all of these needs to and through His people. By sharing these things, we earn the right to share Christ.

Jack and Marilou Dody serve with EQUIP, International. Learn more about EQUIP at www.equipinternational.com. Or write to EQUIP at:

EQUIP
Box 1126
Marion, NC 28752
phone: 828-738-3891

ABUNDACULTURE*

*Co-Operating with God's Designs for Abundance

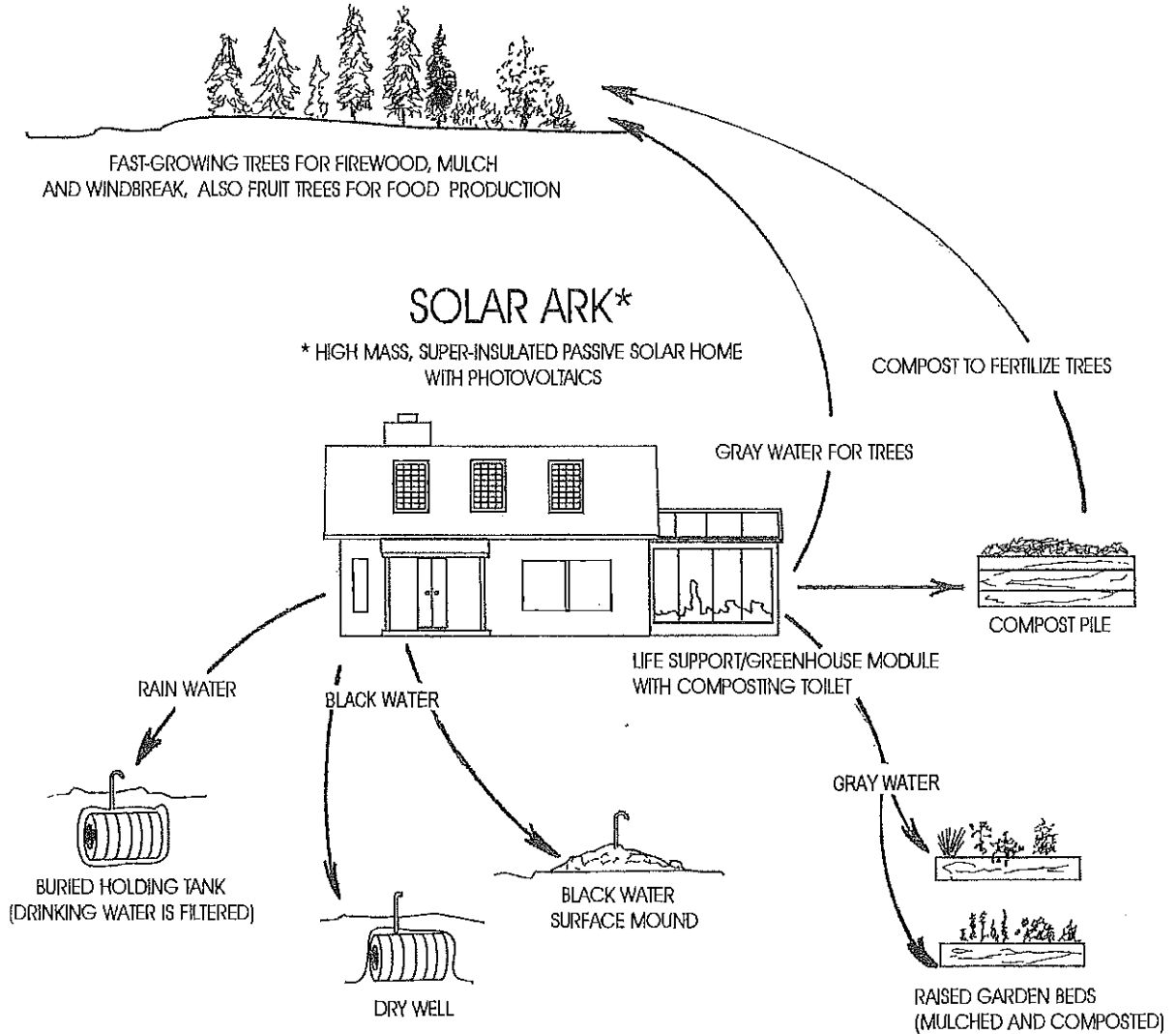

FOUR PRINCIPLES OF SOLAR ARK:

1. On-site Energy Production (Solar Electric and Firewood) Use passive solar designs.
2. On-site Water Collection and Water Conservation (Rainwater Catchment, Gray Water Systems)
3. On-site Food Production (Life Support / Greenhouse Module)
4. On-site Waste Recycling and Disposal (Composting Toilet, Blackwater Systems)

How to get Appropriate Technology help when you're on the field:

1. Download the Abundaculture manual and read it carefully. The manual is available on our website at no charge. The manual is a PDF file. You will need Adobe Reader.

Go to *christianhomesteaders.org*

Go to Articles

Go to Abundaculture

Download

2. If you or your friends need more help, contact us for free consultation:

jack@christianhomesteaders.org

marilou@elpasotel.net

You can phone us at 719 - 360 - 3075.

Write to: Jack Dody

Box 26

Rush, Colorado 80833

Synergy is important in the design and operation of The Solar Ark, For our purposes, *synergy* is how all systems of your home work together. For example, if you catch water from your roof you can use a small, inexpensive pump to have a pressurized water system. If you use gray water for your trees and garden you will need a smaller, less expensive cistern and a simpler, less expensive black water disposal system. If you use a sawdust composting toilet you will not need water to flush your toilet. You will also be able to use your compost to fertilize your trees for firewood and food. If you carefully design your Solar Ark it can be smaller and less expensive. If the structure is smaller, a less expensive photovoltaic system can provide all your electrical needs. If your Solar Ark is carefully designed using proven passive solar principles, less electricity and firewood will be needed for comfort.

Before you build, think of how all systems will function synergistically.

The Solar Ark...

**On-site energy production...
(solar electric, firewood and
passive solar design)**

“Every day enough [solar] energy strikes the United States to supply the nation’s energy needs for one and half years!”

Colorado.edu/essence/texts/solar/htm

STEPS ON THE PATHWAY TO ABUNDANCE

ENERGY PRODUCTION

Matthew 5:45 He [God] causes His sun to rise on the evil and the good...

- Use passive solar principles when designing your home. You will be warm in the winter and cool in the summer with less energy consumption.
- Use photovoltaics to make electricity for your home.
- Use direct solar for cooking whenever possible.
- Use direct solar for hot water whenever possible.
- Use direct solar for food preservation whenever possible.
- Use direct solar for water purification whenever possible.
- Create a woodlot for firewood.

PARTS OF A SIMPLE SOLAR ELECTRIC SYSTEM

Photovoltaic panels - Often called solar panels. Turns sunlight into electricity.

Charge controller-An electronic box that controls the charging of batteries.

Battery bank - One or more batteries used to store power from photovoltaic panels or any other power source.

Generator - A fuel-powered engine attached to a generator used to produce electricity.

Converter or battery charger - An electronic box that changes 120 volt alternating current to direct current, which can charge the battery bank.

Voltmeter - A meter used to monitor the voltage of the battery bank.

Inverter- An electronic box that changes 12 volt direct current to 120 volt alternating current.

Safety disconnect - A device that allows the user to break the connection between the battery bank and the appliances using electricity.

The Photovoltaic Panel

What it does

Turns sunlight into electricity

What it costs

About \$6 per watt (as of 2009) (As low as \$2.50 per watt in 2011)

Advantages

- Easy to wire.
- Expandable. Panels can be added as needs and budgets allow.
- Panels last for decades as they have no moving parts. (Panels on satellites launched in the 1960's are still functional.)

Disadvantages

Expensive. Initial cost per watt is much higher than grid electricity.
Over time, photovoltaic panels are an excellent value.

The Charge Controller

What it does

Controls the charging of the battery bank. Without the controller, the batteries could be overcharged and destroyed. Some controllers protect the batteries against being discharged too deeply.

What it costs

\$60 - \$100's Depending on the size of the system controlled.

New Information (2004)

The new MPPT (Maximum Power Point Tracking) controllers can boost available current from photovoltaic panels by as much as 30%. This is a tremendous boost in efficiency. Cost up to 30% more than standard controllers.

General Information

Some controllers can double as voltage meters.

Some controllers have a switch that will allow batteries to be equalized [see batteries].

The Battery Bank

What it does

The battery bank stores power for later use.

What it costs

Six-volt golf cart batteries are the most popular for small systems at \$120 each (as of 2008). There are many types of batteries, varying greatly in price.

General Information

Batteries are very heavy. Remember this when you make your purchase. You may end up with a monster you cannot move. You may want to purchase very heavy batteries because they will be difficult to steal.

Recommendation

I recommend the 6-volt golf cart batteries for the following reasons:

1. They are affordable at about \$120 (as of December 2008).
2. They are available just about everywhere.
3. They weigh about 65 pounds. This is a manageable weight for most people.
4. They are dependable and easy to maintain.

Safety Alert

When they are being charged or discharged, most batteries create explosive hydrogen gas. Batteries need to be contained in an airtight box built of 3/4-inch plywood that is vented to the outside with a 2-inch PVC pipe.

NOTE: My favorite solar expert for missionaries is Les Eldeen, He recommends DEKA golf cart batteries for price and reliability. (2009)

How to Keep Batteries Alive for Years and Years

(Credit for much of this list goes to Windy Dankoff of Dankoff Solar Products, Inc. 2003. I added several items. Jack)

Note: Don't let the length of this list scare you. I spend about one minute a day on my batteries. About every six months I do a thorough check of the battery bank. It's easy!

Though most consider lead-acid batteries the weak link in renewable energy systems, today's renewable energy batteries are better than ever, and so are the devices that regulate and protect them. Battery failures are rarely the fault of the batteries themselves! Follow these guidelines to avoid the vast majority of all battery problems.

1. Size the battery bank and PV array properly. The battery bank should have a five day load capacity at a minimum. The PV array, should produce (on average) 30% more energy than the load requires. (This is a best case scenario. You may not be able to afford such a perfect system. Jack)
2. Buy high-quality batteries selected for your needs. You get what you pay for! Good deep-cycle batteries can be expected to last for 5 to 15 years, and sometimes more. Cheap batteries can give you trouble in half that time.
3. Connect the two main cables to opposite corners of the battery bank and maintain symmetry in wire size and lengths. This will help to distribute current evenly through the bank.
4. Arrange batteries to maintain even temperature distribution throughout the bank. Avoid uneven exposure to heat sources. Leave at least ½-inch of air space around each battery to promote even cooling.
5. Prevent corrosion. Once corrosion gets hold, it is hard to stop. The good news—it is easy to prevent! Apply a non-hardening sealant to all of the metal parts of the terminals BEFORE ASSEMBLY. A product called NO-CO NCP2 battery corrosive preventative works well. Vaseline or bearing grease will also work.
6. Moderate the temperature. Batteries lose approximately 25% of their capacity at 30 degrees Fahrenheit, compared to a baseline of 77 degrees Fahrenheit. At higher temperatures they deteriorate faster.

7. Install the batteries over a floor drain, or in a space without a floor, so that they can be rinsed with water easily. Washing the battery tops about twice a year will remove accumulated moisture (acid spatter) and dust. (I couldn't put my batteries in an area with a drain. I wash them off with a damp paper towel.)
8. Avoid multiple parallel strings.
9. Use a charge controller, power center or battery charger with temperature compensation. Better yet, place the batteries in a room that is temperature regulated, i.e. heated, insulated, shaded and ventilated.
10. Use an inverter or charge controller with a low-voltage disconnect or get a separate one. Discharging a battery to exhaustion will cause immediate, irreversible loss of capacity and life expectancy.
11. Equalize lead acid batteries once a month. Equalizing means bringing the batteries to a boil at about 15.5 volts for a few hours. This helps remove sulphate from the battery cells. Some charge controllers automatically equalize the battery bank, Other controllers have an equalization switch. Sealed batteries are not equalized.
12. Install a System Monitor, at least a digital voltmeter. Would you drive a car with no dashboard? Metering is not just bells and whistles. I use a BCM-12 LED meter (\$42).
13. Add distilled water as needed. Most batteries require additional water every 6 to 12 months.
14. Avoid sealed marine batteries in solar applications. They can disintegrate and/or explode. ("Solar Power 101 : Batteries", Backwoods Home Magazine, May/June 2004)
16. Do not replace one battery at a time. Remove bad batteries and have a smaller battery bank until the entire bank can be replaced.
17. Get a hydrometer. It costs about \$10. An hydrometer allows you to test each cell in your batteries. If a battery has bad cells it should be removed from the battery bank.
18. Put one teaspoon of Epson salts in each cell of new lead acid batteries.

19. This is the most important aspect of battery care! Check the voltage of the battery bank daily. The best time to check the battery bank is early in the morning before the sun hits the panels and before any energy is used. Your goal is not to go below 80% of full charge, or 12.46 volts. The batteries will last much longer if only the top 20% is used.

% of Charge	Voltage	Specific Gravity
100	12.70	1.265
90	12.58	1.249
80	12.46	1.233
70	12.36	1.218
60	12.28	1.204
50	12.20	1.190
40	12.12	1.176
30	12.04	1.162
20	11.98	1.148
10	11.94	1.134
0	11.90	1.120

These readings are correct at 75° Fahrenheit.
Back Home Magazine, issue 56, p. 14

Batteries are the heart of your power system. They may demand your attention occasionally, but your relationship with them need not be a struggle. With proper installation, a little understanding, and some simple maintenance, your batteries will live long and healthy lives.

The Generator

What it does

Creates electricity using a fuel-driven engine attached to a generator.

What it costs

Depending on size, from a few hundred to several thousand dollars.

Advantages

- Adds great flexibility to a small photovoltaic system. The photovoltaic system can be smaller and less expensive with the addition of a generator.
- Can be used to power tools during the construction of the homestead.
- Can be used to charge the battery bank during cloudy weather.

Disadvantages

- Fuel must be purchased and stored. Gasoline must be rotated regularly; it will last only a few months.
- Noisy and stinky.
- Must be carefully maintained.

Notes

Smaller gas-powered generators typically run at 3600 RPMS.

Larger diesel generators typically run at 1800 RPMS.

Good quality diesel generators can be run constantly and can last for years.

Small, gas-powered generators can be used intermittently - that is, a few hours at a time.

Sizing the generator

A generator that is too large will not work at capacity and will not last.

A generator that is too small will shut down under too great a load and will wear out prematurely.

Suggestion: If you need a small generator most of the time, buy a small generator and rent a larger one when you need it.

Safety alert

Generators create carbon monoxide and must not be used indoors.

The Generator...continued

Operating Tips

- 1) To extend the life of a new unit do the following: Run the new unit for one hour, then drain the oil and replace with new oil. This will remove any metal shavings created during manufacturing. You may further extend engine life by using synthetic oil. If you use synthetic oil continue to change the oil at intervals suggested by the manufacturer. You may be surprised at how often oil changes are needed! Generators "throw" some oil, that is, some oil is used during operation. Check the oil before starting the generator, every time!
- 2) When you start the generator give it a few moments to "smooth out" before sending power to your charger or appliances. Spikes and dips in voltage can occur when the generator is first started and when it is shut down.
- 3) Keep the generator tuned up and running smoothly. A poorly running generator can damage your charger and appliances.
- 4) Disconnect charger or appliances from the generator before you shut it down. Don't allow the generator to run out of gas while it is connected to a charger or appliances.
- 5) Generators tend to vibrate when running. This makes nuts, bolts and screws loosen. When you change the oil, remember to tighten all nuts, bolts and screws.
- 6) Inverter Generators. (2009) Honda, Yamaha and Robin offer new models with built-in, high quality inverters. These units are expensive, but produce high quality electricity for sensitive electronic gear.

The Converter/Charger

What it does

Changes 115-120 volt alternating current to 12 volt direct current, which can be used to charge the battery bank.

What it costs

Depending on size from \$100 to several hundred dollars.

General information

A converter is coupled with a generator. The converter must be sized according to the size of the battery bank. The generator must be sized according to the size of the converter.

EXAMPLE: You calculate that a thirty amp converter will be large enough to charge your battery bank. A 3500 watt generator will be needed to power the thirty amp converter.

The Voltmeter

What it does

Meters the voltage of the battery bank.

What it costs

For a digital unit, approximately \$10 - \$100. An analog unit with bouncing arrows is worthless.

Why it is important

For long battery life, just the top 20% of the battery should be used. In order to determine the battery's stage of charge, a voltmeter is used. The voltmeter should be checked daily, in the morning, before the sun hits the photovoltaic panels and before the batteries are discharged by use.

NOTE: The voltmeter I use now is a BCM-12 LED meter. The cost was \$42. At a glance you will always know exactly what is happening to your batteries. (2009)

The Inverter

What it does

Changes direct current (DC) to alternating current (AC). Some inverters also double as battery chargers.

What it cost

Depending on size and quality, \$100 to several \$1000.

Why it is important

The inverter allows the use of standard AC products. Smaller wire can be used when using AC as opposed to DC.

Important information

Certain AC products will not work with inverter power, i.e., certain printers, certain computers, some stereo gear, some battery chargers for power tools, ceiling fans, etc. Call manufacturers with questions before you purchase or ask others who live off-the-grid.

SIMPLE, 12 VDC, OFF-GRID PHOTOVOLTAIC SYSTEM

© 2009 Jack Dody

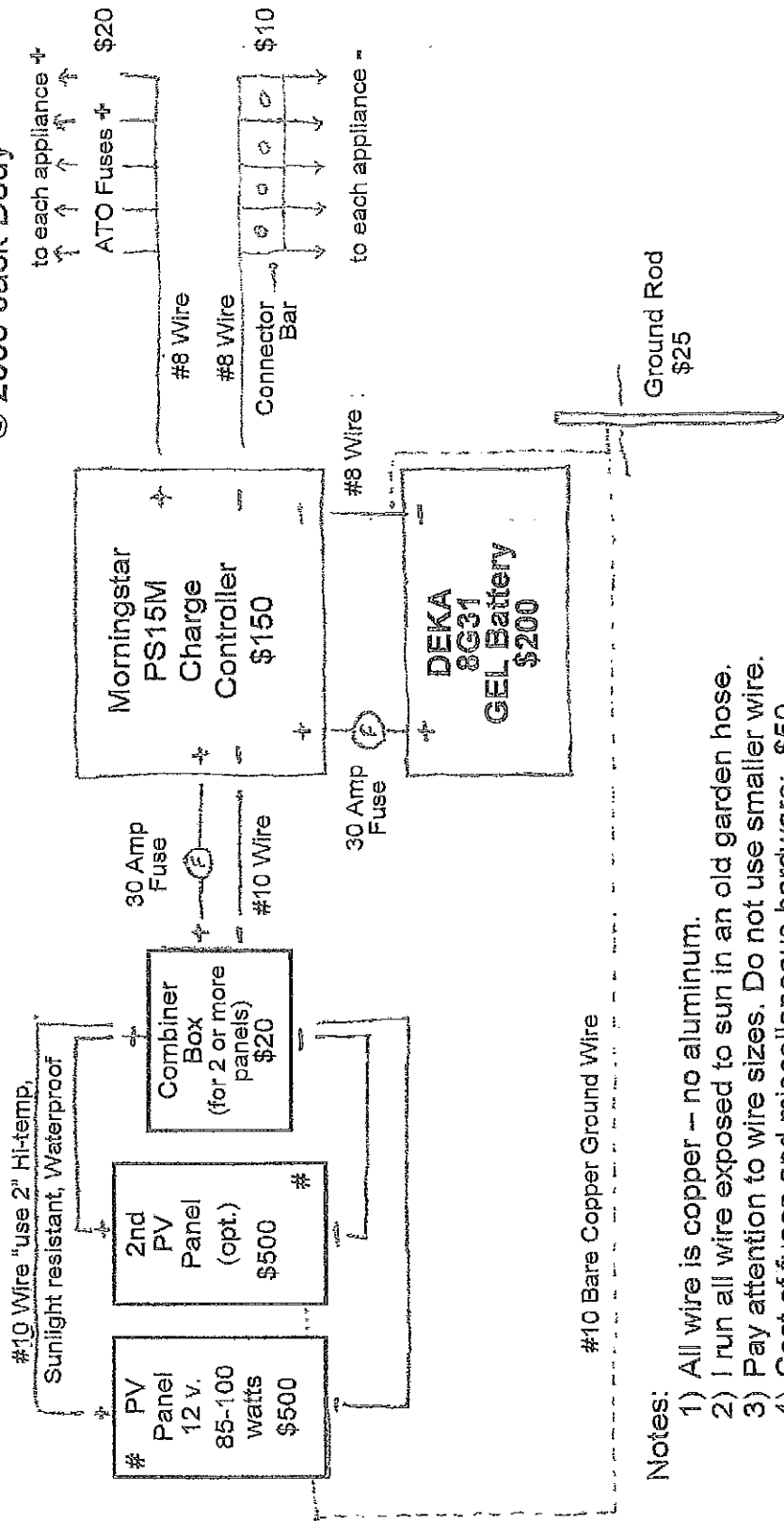

Notes:

- 1) All wire is copper – no aluminum.
- 2) I run all wire exposed to sun in an old garden hose.
- 3) Pay attention to wire sizes. Do not use smaller wire.
- 4) Cost of fuses and miscellaneous hardware: \$50.
- 5) Cost of wire: \$50.

Total cost with one panel: \$1005.

Total cost with two panels: \$1525.

Installing a Small, 12 volt, Off-Grid Solar System 2009

Disclaimers: Information for a safe solar system is presented here. Do not substitute materials. I cannot take responsibility for creative ways you may decide to screw up.

This installation will not meet national electric code standards. If you must build to code, hang on to your wallet, and may God be with you.

Sources: The following ideas are from...

- *Low-Voltage Wiring* by Tom Moates, *Back Home Magazine*, September/October 2003, pp. 20-23.
- *Installing Your Own Small, Remote Off-Grid Solar System* by Jeffrey R. Yago, *Backwoods Home Magazine*, March/April 2009, pp. 35-40.
- and from 35 years of personal experience.

Why have a 12-volt system?

- A. Cost. It is much less expensive. Inverters can cost thousands of dollars.
- B. Simplicity. With a few components, your system is complete.
- C. Efficiency. A 12-volt system is more efficient. For example, a single light bulb using AC pulled from an inverter can draw at least twice the battery current as a DC bulb drawing directly from the batteries.
- D. Safety. A 12-volt system can be safer. It is difficult to electrocute yourself with 12 volts!

What is a "small" system?

In this case, a system with up to 400 watts of 12-volt photovoltaic panels.

Panel to Battery Ratios

Assuming that you will have at least five hours of bright sun on most days, it would be ideal to have 200 watts of panels to charge each battery, assuming the batteries are the ones suggested in these plans.

(One battery will store about 1 KWH of electricity when discharged to 50%)

You can use fewer panels per battery to start your system and work toward an ideal system as your budget allows. If you live in a cloudy place, you may need more panels per battery.

To keep your budget within reason, you can experiment with your battery to panel ratio. How you use your system will determine how many panels and batteries you need. I have 400 watts of panels and a 400 watt wind generator charging ten batteries. In sunny Colorado, this has worked well. I also use a generator and a battery charger about five or six times a year to assist my panels and windcharger on grey, windless days.

How Much Electricity Will a Small 12 VDC System Provide?

If you are careful to turn off lights and other appliances when they are not being used, you should be able to operate 4 or 5 LED or CFL lights, a 12-volt RV water pump, a small fan and a laptop computer. When the sun is shining brightly, you can use your system for a variety of other tasks: pumping water for the garden, powering electric tools, etc.

What Kind of Batteries Should I Use?

For the sake of simplicity, I suggest a sealed, gel, deep-cell battery. DEKA brand batteries have an excellent reputation for durability. If you buy cheap batteries, you will have to replace them more often. Never use auto batteries. They are not designed for this purpose and will be a waste of money.

Sealed batteries are maintenance-free and leak proof. The most important feature is that these batteries do not have to be vented. Unlike sealed gel batteries, lead acid batteries must be refilled from time to time with distilled water and must be vented to the outside because they create explosive hydrogen gas when being charged or discharged. While sealed gel

batteries cost 40% more than comparable lead acid batteries, I believe they make sense for the beginning solar electric user or the person who does not want to worry about their batteries.

Note: Your charge controller must have a setting for gel batteries to prevent battery damage.

Note: Batteries are heavy! Make sure you will be able to move them and that your structure will support them. I purchase batteries that weight about 70 pounds. Most people can handle 70 pounds. You may want heavier batteries to make theft difficult.

Note: Batteries operate best at temperatures between 50°- 90°F. For this reason and to discourage theft, I put my batteries inside my living space.

For this small system, I am going to start with one 85 watt 12-volt Kyocera photovoltaic panel (\$500) and one 12-volt, DEKA, gel cell battery, model #8G31 (\$200).

What About a Refrigerator?

A very small system (200 watts of panels and one or two batteries) will not produce enough power for even the most efficient (and expensive, \$900-\$1500) refrigerators and freezers. With 400 watts of panels and four batteries, you may sometimes run a bit short of power. You may want to look at small Sun Danzer freezer. You can make ice and place it in an ice chest. You will get maximum performance for minimum dollars in this way. Others options for refrigeration are propane and kerosene refrigerators and freezers. I have a Danby propane refrigerator/freezer (\$1000) that has given me excellent service. Still, if I had the money, I would invest in the extra solar for a Sun Danzer refrigerator/freezer. Propane is expensive and still going up!

The Charge Controller

The charge controller is the brain of your system. It protects your batteries from over-charging and over-discharging. I recommend the Morningstar PS series because of their price, features and dependability. Two features

are particularly helpful. A built-in battery disconnect allows you to isolate the battery bank for safety or maintenance. The other great feature is the metering. I always put the charge controller where I can easily see the meters. With a digital LCD display, the Morningstar tells me the voltage of my batteries, the amount of amps coming from my panels and the amount of amps that I am using. The controller has LED lights that warn me of any problems. It also has a switch for sealed batteries.

Wire Sizing for a 12-VDC System

12 VDC needs heavier wiring than 120 VAC. Using copper wiring (no aluminum) at lengths of 50 feet or less, use the following chart:

LOAD	AC Sizing	DC Sizing
10 amps	#14	#14
15 amps	#14	#12
20 amps	#12	#10
30 amps	#10	#8
60 amps	#6	#4
100 amps	#2	#1

If your wire run is longer than 50 feet, go to the next larger size of wire. Keep all wire runs as short as possible. Put panels and battery banks as close together as possible.

Wire Connections

To attach heavy wire to switches, receptacles and fuse boxes, ring terminals and blade-type connectors, available at good automotive parts stores, should be soldered to wire ends. Do not just clamp on connectors. Often I add a pigtail of stranded wire to the end of my solid wire because it is more flexible and easier to manipulate.

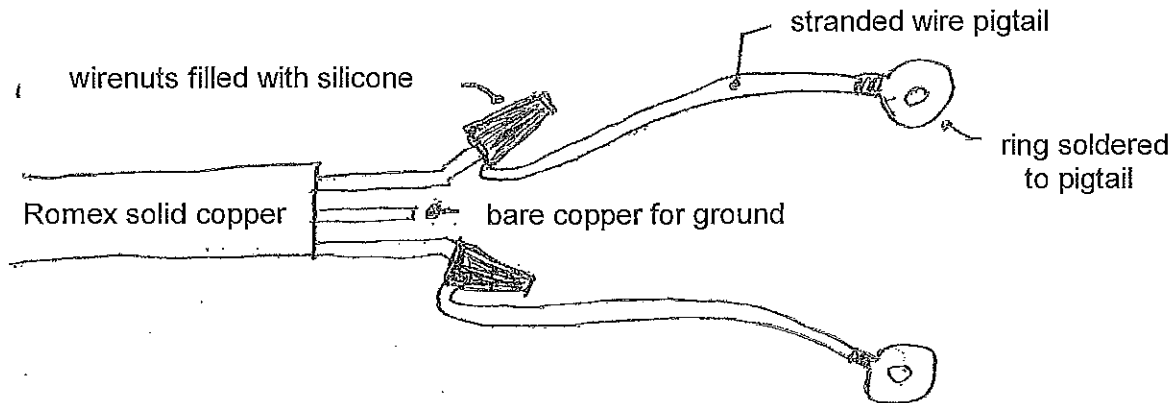

Note: Solder – there are two types of solder typically available, one for electrical use and one for plumbing. Use electrical, rosin-core solder.

Corrosion

After wires are attached, all bare connections should be treated with a corrosion preventative, available at an auto parts store. A product called NO-CO NCP₂ works well. Vaseline or bearing grease or silicone will also work. Silicone is permanent. Do not put it on any screws or bolts that may need to be tightened or removed at some future time.

Receptacles

Do not use standard AC receptacles for a 12-volt system. If you plug a 120-volt AC appliance into a standard receptacle wired for 12 VDC, you will ruin your appliance. You can use a 20-amp, 250-volt receptacle. The receptacle pattern design should be different from a standard 120-volt AC receptacle so that it is physically impossible to ruin AC appliances.

I use 12-volt cigarette lighter receptacles because it is simple. Most 12 VDC appliances have a cigarette lighter-type plug.

Switches

You can use 12 VDC switches that you can buy at any auto parts store. You will often read that standard AC switches will not work in a 12 VDC system. My friend, Les Eldeen, who has installed more than 8000 solar systems, informs me that he uses standard switches in his systems with no problems. You can avoid the switch issue and simplify your wiring by purchasing 12 VDC light fixtures with built-in switches, available at RV dealers.

Breakers and Fuses

If you like breakers, the Square D "QO" line of AC breakers will work for 12 VDC. This only applies to the "QO" line by Square D.

I use ATC blade-type automobile fuses because of cost and availability.

Every circuit should be fused. This helps prevent fires and protects appliances. Include a fuse in the positive wire between the solar panels and charge controller, and between the charge controller and the battery.

System Grounding

Proper grounding will help prevent lightning damage. Every solar module has a predrilled and labeled hole in the frame for a ground wire. Use #10 bare-copper wire to connect to each module. Then run the wire to a copper clad ½ -inch steel ground rod driven next to your home's foundation. Wherever a connection is made, use a corrosion preventative.

Each receptacle or switch need not be grounded using the bare copper wire in standard romex cable. **This applies only to 12 VDC systems.** Romex cable is the type of highly insulated wire that is typically seen in house wiring.

Installing Photovoltaic Panels

Note: When installing panels, cover them with a tarp to avoid sparks and electric surges during installation.

Panels must face the sun directly (usually south) and must not be shaded in any way. Even just a little shading will dramatically decrease panel output. The panels can be mounted on your roof or on a pole. In areas where theft is a problem, panels can be welded on a 15-foot metal pole placed in lots of concrete.

Solar panels produce the best year-round performance with a tilt angle equal to your latitude. For most of the United States, this is from 37-42 degrees. A lesser angle will improve summer output, and a steeper angle will be better in winter.

Make sure the panels are securely mounted so that they cannot be blown away by the wind. Wind-lift is a problem. Use stainless steel screws or lag bolts that are anchored into studs, not just plywood sheeting.

Wiring Your System

Safety Note: You must avoid "crossing your wires", that is attaching positive wires to negative posts or vice versa. Use black for positive and white for negative. For this small 12 VDC system, the bare copper ground in romex wire need not be used at each appliance. Ground the system as shown on the diagram. Plus and minus are clearly marked on the panels, the charge controller and the batteries. **PAY ATTENTION!**

Safety Note: Do not connect batteries until all other connections are made and tested.

The 12-volt panels should be wired in parallel, that is plus to plus and minus to minus.

If you have more than one panel, you should use a combiner box located close to the panels. Notice that each panel runs directly to the combiner box. Use copper wire, type "use 2" or equivalent. This wire is high temp,

sunlight and waterproof. Because the ultraviolet rays can be so damaging, I run any wire exposed to the sun in an old piece of garden hose.

Follow the diagram carefully, noting wire types and sizes.

Connect the wires from the panels to the charge controller. Be sure to include a 30 amp fuse on the plus (+) side between panels and the charge controller. Run wires from the charge controller to your batteries but do not connect them yet. Be sure to include a 30 amp fuse on the plus (+) side between the charge controller and the battery. Run wires from the charge controller to the fuse box or breaker box. Run wires to individual lights and receptacles.

Double check every connection for shorts (i.e., plus being connected to minus.)

Carefully connect your batteries. Carefully touch the wires coming off of the batteries. They may become slightly warm, but not hot. If they are hot, disconnect them immediately. If your fuses blow, disconnect the batteries immediately. Check again for shorts. Black wires to positive, white wires to negative. Reconnect your batteries and check them again.

After you have the batteries connected and working without overheating, check each circuit for proper fuse size as follows:

Turn on every light or appliance typically used in the circuit. Start with small amp fuses. If they are too small, they will blow quickly. Try the next size higher amp fuse. A fuse that is too heavy for the circuit can cause fire or damage to appliances before it blows. A fuse that is too small will blow often. You are Goldilocks looking for the fuse that is "just right".

Finally, make a chart that shows what appliances are on each circuit and what size fuse is required. Keep the chart close to your fuse box.

Example:

Fuse #1.....water pump.....	9 amps
Fuse #2.....bedroom lights.....	30 amps
Fuse #3.....receptacle by kitchen sink...	20 amps

ENJOY YOUR ELECTRICITY!

SUCCESS WITH SOLAR

Here are some tips to maximize your solar system:

1. Avoid phantom loads (clocks, remote controls, etc.) These appliances are always drawing power, 24 hours a day!
2. Use another source of power (propane or kerosene) for refrigeration. Sundanzer DC refrigerators and freezers (www.sundanzer.com) that operate on solar electricity are excellent, but expensive. You may want to consider a root cellar or other forms of preserving foods.
3. Use LED or florescent lighting.
4. Put lights close to work areas. Where a fixture is placed will determine how effective the lighting is.

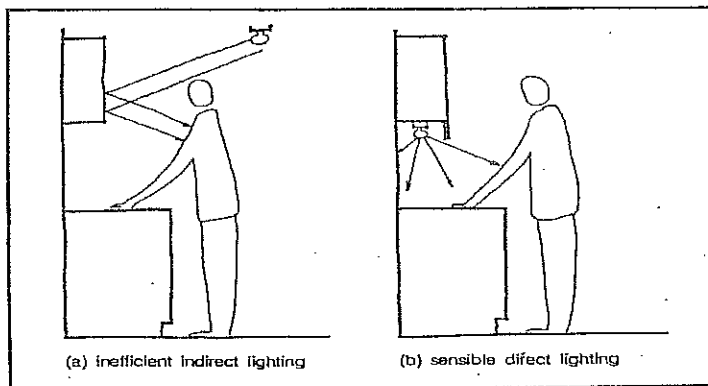

(Illustration from: *More Other Homes and Garbage*, Sierra Club 1981)

5. Use smaller fans, placed close to your body or 12-volt ceiling fans, (120-volt ceiling fans don't work well with inverters.)
6. Use the smallest pump that will do the job.
7. Use direct current whenever possible.
8. Take good care of your batteries. Check them every day. Use only the top 20% of the batteries' power.
9. Adjust your panels at least twice a year to maximize power output. Panels should be perpendicular to the noonday sun.
10. Portable radios and clocks work well with AAA, AA, C and D batteries. Powering these appliances with small batteries helps keep your electric system simpler and smaller.
11. Compact florescent (CFLs) provide the most light per watt. (LEDs are a close second.) CFLs are most suitable to illuminate larger spaces.
12. Use stick-on push lights with LEDs. These are battery powered and easy to use. They cost about \$4 each and are great where you need light for short periods of time—by the toilet, by the front door so you can see the lock, etc.
13. Consider when you use energy. If you use power in the morning, the batteries have time to recharge.

Typical Wattage Requirements for Common Appliances

Use the manufacturer's specs if possible, but be careful of nameplate ratings that are the highest possible electrical draw for that appliance. Beware of appliances that have a "standby" mode and are really "on" 24 hours a day. (chart updated 2009)

<u>DESCRIPTIONS</u>	<u>WATTS</u>
<u>Kitchen Appliances</u>	
Refrigeration:	
4-yr. old 22 cu. ft. auto defrost (approx. run time 7-9 hours per day).....	500
New 22 cu. ft. auto defrost (approx. run time 7-8 hours per day).....	200
12 cu. ft. Sun Frost refrigerator (approx. run time 6-9 hours per day).....	58
4-yr.-old standard freezer (approx. run time 7-8 hours per day).....	350
NOTE: Refrigerators are improving. Check new products for new ratings.	
Blender.....	350
Can opener (electric).....	100
Coffee grinder.....	100
Coffeemaker.....	850-1200
Deep fat fryer.....	1380
Dishwasher: cool dry.....	700
Dishwasher: hot dry.....	1450
Egg cooker.....	500
Exhaust Hood.....	144
Food Dehydrator.....	600
Food processor.....	400
Food waste disposer.....	420
Fruit Juicer.....	100
Frying pan.....	1170
Grill, sandwich.....	1050
Hot plate.....	1250
Microwave (.5 cu. ft.).....	900
Microwave (.8 to 1.5 cu. ft.).....	1500
Mixer.....	120
Range, large burner.....	2100

<u>DESCRIPTIONS</u>	<u>WATTS</u>
Range, small burner.....	1250
Range, Amana (propane) with glow bar.....	380
Roaster.....	1345
Slow cooker (crockpot).....	180-240
Toaster (2-slice).....	750-1200
Trash compactor.....	1500
Waffle iron.....	1080

Water Pumping

AC Jet Pump (1/2 hp) 300 gal. per hour, 20-foot well depth, 30 psi.....	750
AC Submersible Pump (1/2 hp), 40-foot well depth, 30 psi.....	1000
DC pump for house pressure system (typical use is 1-2 hours per day).....	60
DC submersible pump (typical use is 6 hours per day)...	50

Shop

AC grinder, 1/2 hp.....	1080
AC table saw, 10 inch.....	1800
Hand drill, 1/2 inch.....	600
Hand drill, 3/8".....	400
Lathe (12 inch).....	660
Router.....	720
Sander (orbital).....	300
Saw, band.....	660
Saw, circular.....	1080
Saw, saber.....	288
Saw, table.....	950
Worm drive 7 1/4 -inch saw.....	1800

<u>DESCRIPTIONS</u>	<u>WATTS</u>
<u>General Household</u>	
Air conditioner, 1 ton or 10,000 BT/hr.	1500
Air conditioner, window....	1300-1500
Alarm/security system.....	6
Clock radio.....	5
Clock, electric.....	4
Clothes dryer, electric.....	4800-5750
Clothes dryer, gas.....	300-500
Clothes washer, horizontal axis..	145-250
Clothes washer, vertical axis.....	900
Dehumidifier.....	240
Electric blanket.....	170-400
Electrostatic cleaner.....	60
Fan, attic.....	375
Fan, circulating.....	85
Fan, furnace 1/4 hp.....	600
Fan, furnace 1/3 hp.....	700
Fan, furnace 1/2 hp.....	875
Fan, roll about.....	205
Fan, window.....	190
Floor polisher.....	315
Fountain, tabletop.....	5
Garage door opener, 1/4 hp.....	550
Germicidal lamp.....	20
Heat lamp (infrared).....	250
Heat pump.....	9600
Heater, radiant.....	1300
Heating pad.....	60
Humidifier.....	70
Iron (electric).....	1200
Light bulb, incandescent.....(on bulb)	
Light bulb, typical fluorescent light (60W equivalent).....	15
Oil burner or stoker.....	260
Serger (Pfaff).....	140
Sewing machine.....	75
Vacuum cleaner, average.....	900
Vacuum, central.....	1500
Vacuum, Oreck.....	410
Vacuum, Dirt Devil upright.....	980
Water heater, quick recovery....	4500
Water heater, standard.....	3000
Waterbed heater.....	300

<u>DESCRIPTIONS</u>	<u>WATTS</u>
<u>Hygiene</u>	
Hair curler.....	750
Hairdryer.....	400-1500
Shaver, electric.....	15
Sunlamp.....	290
Toothbrush, electric, charging stand.....	6
Waterpik.....	90
Whirlpool bath.....	750

Entertainment/Telephone

CB (receiving).....	10
Guitar amp (Jimi Hendrix volume).....	8500
Guitar amplifier (avg. volume).....	40
Laser disk/CD player.....	30
Piano, electric.....	30
Radio.....	80
Satellite system, 12-ft dish/VCR....	30
Stereo home theater, AC.....	500
Stereo, AC (avg. volume).....	25-55
Stereo, DC (avg. volume).....	10-15
Telephone, cellular (on standby).....	5
Telephone, cordless (on standby)...	5
TV, 12-inch black & white.....	16
TV, 19-inch color.....	50-80
TV, 27-inch color.....	120-170
LCD TVs use less power than older models: LCD 50-inch TV.....	175
Video games (excluding TV).....	20

Office/Den

Adding machine.....	8
Computer, desktop.....	90
Computer, laptop.....	25
Fax machine, plain paper printing.....	50
standby.....	5
Monitor, 15-inch LCD display.....	35
Monitor, 17-inch flat screen.....	50
Monitor, 17-inch color.....	100
Pencil sharpener, electric.....	60
Printer, ink jet.....	15
Printer, laser.....	600-900
Typewriter, electric.....	200

Approximate Average Power Consumption of Widely Available 12-volt DC Appliances

DESCRIPTIONS AMPS

Lighting

15-watt fluorescent light.....	1.0
16-watt slimline fluorescent light ..	1.2
Dual 8-watt fluorescent tubes	1.2
20-watt standard fluorescent light	1.5
30 watt slimline fluorescent light ..	2.0

Kitchen

Coffee percolator	11.5
Toaster.....	15.0
Slow cooker	20.0
Range hood, fan and light.....	5.0
Vent fan	2.5
Refrigerator.....	5.0
Sundancer Refrig/Freezer... ..	0.5-11.0

Household

Travel iron.....	10.0
Electronic bug killer.....	2.5
Electric razor	1.3
Vacuum cleaner, hand portable ...	5.0
Electric toothbrush	1.0

Tools

Winches (for light use)	10.0-100.0
Air compressor.....	3.5-9.0
Chain saw, 14" blade	100.0
Drill.....	12.0-15.0

Communications

TV, B&W, 12"	1.4
TV, Color, 9"	4.0
CB radio.....	0.5
Digital clock.....	0.1
Tape recorder	0.5
Amplifier (30 watt).....	2.0
DC turntable.....	0.5

FORMULA TO COMPUTE AMP-HOURS

Light	1.5 amps x 6 hours = 9.0 amp-hrs
Coffee maker 11.5 amps x 1 hour = 11.5 amp-hrs
TV	1.4 amps x 3 hours = 4.2 amp-hrs

Total (of this example) 24.7 amp-hrs.

TYPICAL WATTAGE REQUIREMENTS FOR 12 VDC APPLIANCES

Shurflo 12 VDC pump

O₂ Cool fan..... low .3 amps
..... hi .6 amps

From *RV Repair and Maintenance Manual*, p.
24. Edited by Bob Livingston ©1989

Recommended Reading

Earthships I, II, III

The Evolution of an Independent Home, Paul Jeffrey Fowler, Fowler Enterprises, 264 Bashan Hill Road, P.O. Box 253, Worthington, MA 01098-0253. This book shows how you can start small and build over time. The advice is real and practical.

Backwoods Home Magazine / BackHome Magazine / Countryside Magazine These three publications will provide many examples of working energy systems. Most of the systems are owner-built.

HomePower Magazine, www.homepower.com Excellent examples of both small and large homemade power systems.

From Eco-Cities to Living Machines, by Nancy Jack Todd and John Todd, © 1994. Lots of interesting ideas using biology and solar power to solve living problems. Authors are committed socialists/communists.

On the net: Rex Ewing, author of several fine books. Mr. Ewing covers both simple and complex solar electric systems. (2010)

LEARN MORE ABOUT SOLAR POWER

(This is a resource list from Mother Earth News, *A Guide to Homes*, Summer 2003, p. 26.) updated 2009

SOLAR PRODUCTS MANUFACTURERS

These sites provide useful information about solar energy in general, about specific products and, in some cases, distributors and installers.

Bekaert ECD Solar Systems (Uni-Solar thin film roofing) www.uni-solar.com

Affordable Solar www.affordable-solar.com

Evergreen www.evergreensolar.com

Astropower www.astropower.com

Siemens Solar www.siemenssolar.com

Kyocera Solar www.kyocerasolar.com

Atlantis Energy Systems www.atlantisenergy.com

PowerLight www.powerlight.com

ON MOTHER'S BOOKSHELF, PAGE 103

The New Independent Home, by Michael Potts, \$30

The Natural House, by Dan Chiras, \$35

GENERAL INFORMATION

National Renewable Energy Laboratories www.nrel.gov

Energy Efficiency and Renewable Energy Network www.eren.doe.gov (800)363-3732

A Consumer's Guide to Buying a Solar Electric System
www.nrel.gov/docs/fy99osti/26591.pdf

American Solar Energy Society www.solartoday.org (303)443-3130

California Energy Commission www.energy.ca.gov

Center for Renewable Energy and Sustainable Technology (CREST)
www.crest.org

Real Goods Institute for Solar Living
www.realgoods.com/renew/intertie/index.cfm

Florida Solar Energy Center www.fsec.ucf.edu

The Solar Electric Power Association www.solarelectricpower.org

DEPENDABLE SOLAR PRODUCT DEALERS (as of 2009)

Note: These dealers have been in business for several years and have a solid track record. Because there are so many fly-by-night solar businesses, I suggest that you find a reputable dealer. You will probably need service after the sale.

Help Designing Solar Electric – Les Eldeen
www.sunbeamsolutions.com

Note: Mr. Eldeen has designed more than 8000 systems for missionaries around the world.

Kansas Wind Power – www.kansaswindpower.net

Backwoods Solar Electric – www.backwoodssolar.com

Affordable Solar – www.affordable-solar.com

Alternative Choices – acsolar@earthlink.net / www.acsolar.com

Sunbeam Solutions – www.sunbeamsolutions.com

STEPS ON THE PATHWAY TO ABUNDANCE

HOUSING

Note: We call the home we have designed a Solar Ark. It has special features listed below that make it an essential component of abundant living.

Psalm 127:1 *Unless the Lord builds the house, its builders labor in vain.*

Build without a mortgage

Luke 14:28 *[Jesus speaking] Suppose one of you wants to build a tower. Will he not first sit down and estimate the cost to see if he has enough money to complete it?*

Proverbs 22:26-27 *Do not be a man who strikes hands in pledge or put up security for debts; If you lack the means to pay, your very bed will be snatched from under you.*

Use passive solar design principles.

Use local materials whenever possible.

Recycle and reuse building materials.

Consider alternative building methods: tires, bags, straw, cob, etc.

Plant trees for firewood, energy and building materials.

Heat your home with solar and wood.

Heat water for your home with solar and wood.

Use refrigeration devices designed for photovoltaics.

Include water catchment in your home design.

Include composting toilets in your design.

Always include a greenhouse or a place to start plants for your garden.

Designing Your Solar Ark

Review: Four Traits of the Solar Ark

1. On-site energy production.
2. On-site water collection and water conservation.
3. On-site food production.
4. On-site waste recycling and disposal.

A Solar Ark can be built in any location, in any climate.

How you build your Ark depends upon:

1. Available materials
2. Climate considerations
3. Budget considerations
4. Cultural considerations

Designing Your Solar Ark

from Malcolm Wells – the father of Earth-Sheltered Design

A list of 15 properties of an excellent building.

1. Create pure air.
2. Create pure water.
3. Store rainwater.
4. Produce its own food.
5. Create rich soil.
6. Use solar energy.
7. Store solar energy.
8. Create silence.
9. Consume its own wastes.
10. Maintain itself.
11. Match nature's pace.
12. Provide wildlife habitat.
13. Provide human habitat.
14. Moderate climate and weather.
15. Be beautiful.

Designing Your Solar Ark

from "The New Ecological Home"

by Daniel D. Chiras

Keys to Successful Passive Solar Design

1. Choose a site with unobstructed solar access.
2. For optimal solar gain, orient your house so that its long axis lies on an east-west axis.
3. Concentrate windows on the south side of the house.
4. Include overhangs, especially on the south side of the house.
5. For maximum comfort, include an adequate amount of thermal mass in your design.
6. All solar design relies on energy efficiency.
7. Protect insulation from moisture.
8. Design your house so that most, if not all, of the rooms are heated directly by incoming sunlight.
9. Create sun-free zones in your home.
10. Install an efficient, properly sized, environmentally responsible back-up heating system.

Summary of Principles of Sustainable Design and Construction (by Daniel D. Chiras)

- Build small.
- Make homes efficient.
- Use recycled or recyclable materials.
- Recycle and compost all waste.
- Build recycling centers in homes
- Use renewable resources, especially energy.
- Promote environmental restoration.
- Create safe, healthy living spaces
- Make homes easy to operate, service, and maintain.
- Design homes to be accessible.
- Make homes affordable.
- Make homes durable.
- Build community.

BASIC COMPONENTS OF SUCCESSFUL PASSIVE SOLAR CONSTRUCTION

EASY AS 1, 2, 3!

1. WINDOWS
2. INSULATION
3. THERMAL MASS

Note: A well-designed passive solar home will be comfortable all year long in any climate.

WINDOWS

Sizing - Windows should cover an area equal to 17-22% of the square footage of the home.

Placement - Most windows should be on the sunny side. Minimize windows on the cold side. Placing bathrooms, bedrooms, closets, storage areas and garages on the cold side helps minimize windows and acts as a thermal block.

Construction - Use double-paned windows. Frames should be constructed of wood or vinyl to prevent convection. Insulated, moveable window coverings can be effective in cold climates.

Eaves - Sunny side windows should be shaded by eaves to prevent summer sun from overheating living spaces. On the sundown side of the structure, shades, shutters and curtains can prevent overheating.

Window Allocations in Direct-Gain Systems

(from "The New Ecological Home"
by Daniel D. Chiras)

South-facing glass – 7 to 12%*

North-facing glass – no more
than 4%

East-facing glass – no more
than 4%

West-facing glass – no more
than 2%

* percentages are based on total
square footage of a home.
Window space is glass area (total
window space minus frame).

INSULATION...THE KEY TO COMFORT

WHAT IS INSULATION?

Insulation is any material that resists the transfer of heat or cold. This resistance is represented by the letter "R". The R-value provides information about the effectiveness of insulating materials. The higher the R-value, the greater the resistance and insulating capability. Usually, insulation traps air in cells. It is the dead air that slows the movement of heat and cold. The smaller the air cells are, the better. Because insulation is mostly air it is often very light-weight.

HOW TO HAVE SUCCESS WITH INSULATION

1. Use enough insulation to be effective in winter and in summer. If you are using non-standard types of insulation, use more. You may have to increase the thickness of walls to provide enough space for adequate insulation. Example: Walls could be 12 inches thick instead of 4 or 6. Find out how much insulation is being used in your area. Increase that amount by a few inches, if possible.
2. Insulation must be used in a fire-safe way. Keep insulation behind low-combustion materials like drywall or plaster. Be careful when running wire near combustible materials. Consider wire encased in metal conduit. Always be ready for fire with extinguishers and alarms.
3. Keep insulation dry. Learn when and how to use moisture barriers.

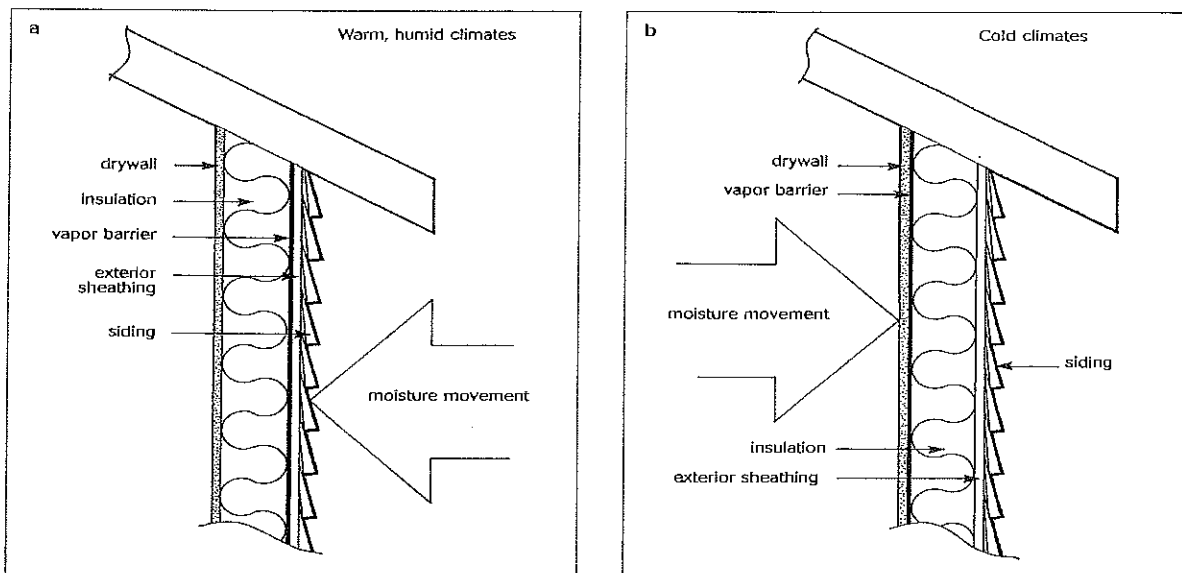

Vapor barriers are neipru in nearly any home. They prevent moisture from penetrating the wall and thus help keep insulation dry. Even a tiny amount of moisture in insulation dramatically reduces its R-value. In warm climates, moisture barriers are typically installed just beneath the exterior sheathing (a). In cold climates, moisture barriers are usually installed beneath the drywall (b). [source: David Smith in "The New Ecological Home" by Daniel D. Chiras] The new vapor barrier materials breathe", allowing moisture out of wall cavities.

4. Insulate carefully. Fill every void. Use caulking where needed. Eliminate leaks and cracks. Plan for settling. If you use a loose-fill type of insulation in walls it will probably settle. Let it. Push it down, then fill the void created with a springy type of insulation like fiberglass or plastic bags. Fill the void as tightly as possible to allow for future settling. If settling occurs, use an expanding foam like "Great Stuff." It may take a few years for settling to occur.
5. Provide adequate ventilation in your living space. This will help eliminate condensation problems.
6. Use the cleanest, driest materials available. Use organic pest deterrents like borax, diatomaceous earth, salt, etc.
7. Take steps to deal with conductivity. Conductivity is the transfer of heat or cold through solid materials like studs and window frames. Styrofoam sheathing is one way to deal with conductivity and provides a moisture barrier.
8. Combine proper amounts of insulation with proper amounts of mass to create a comfortable living space.
9. Consider solar radiation. Use a reflective materials like aluminum foil on walls and roof surfaces that are exposed to direct sun. White roofing reflects a great deal of heat.
10. Insulating floors over an unheated basement beyond the thickness of the joists is usually not worth the extra effort.
11. Insulating heated crawl spaces beyond R-19 is not cost effective.

Sources: Superinsulated Design and Construction by Lenchek-Mattock-Raabe, © 1987 Van Nostrand Reinhold Co., Inc.

Solar Living Meredith Corp., © 1983 Better Homes and Gardens Books

TRADITIONAL TYPES OF INSULATION

NOTE: R-values notated per inch

FIBERGLASS...R-value 2.9 - 3.7... Positive features: Good availability. Inexpensive. New types do not irritate skin. Fire resistant. Negative features: Old type irritates skin and lungs during installation.

STYROFOAM...R-value 3.7 -4.0... Positive features: Lightweight. Rigid. The blue stuff can be buried. Excellent for outside perimeter insulation. Can be used under roofing. Negative features: Creates poisonous gas if burned.

ROCK WOOL... R-value 2.9 - 3.7... Positive features: Inexpensive. Fire resistant. Negative features: irritates skin and lungs during installation.

CELLULOSE(SHREDDED PAPER)... R-value 3.1 - 3.7... Positive features: Easy to blow in. Non-irritating. Non-flammable. Uses recycled paper. Negative features: Flame retardant (borax) can corrode metal. Absorbs moisture. May settle.

VERMICULITE AND PERLITE... R-value 2.1 -2.7... Positive features: Fire resistant. Negative features: Low R-value. May settle. Expensive in some areas.

POLYURETHANE AND ICYNENE... R-value 5.8-6.2... Positive features: Expands to fill voids. Moisture resistant, High R-value. Negative features: Expensive. Requires professional installation. Gives off toxic fumes when burning.

POLYISOCYANURATE BOARD... R-value 5.9 - 7.0... Positive features: High R-value. Rigid board, can be foil-faced. Negative features: Expensive. Gives off toxic fumes when burning.

REFLECTIVE INSULATION... R-Value N/A...usually made with shiny aluminum foil. Positive features: Keeps the sun's heat from entering the living space. Helps keep a living space cool in very sunny areas. Negative features: Expensive. Must be installed very carefully.

NON-TRADITIONAL TYPES OF INSULATION

NOTE: Non-traditional insulation is often flammable. Care must be taken to lessen fire danger. Pests and vermin could also pose problems unless materials are very clean and very dry. Organic pest controls may be necessary.

COTTON...R-value 2.9 - 3.7... Positive features: Non-irritating. More dense than fiberglass, i.e. better sound proofing. Treated for fire resistance. Negative features: New product. Not readily available. Expensive.

STRAW... R-value approximately 35 for a standard bale... Positive features: Available. Easy to use. Negative features: Must be very dry. Must be covered with adobe or plaster to protect it from fire and animals. Loose straw is sometimes mixed with salt and placed in walls and ceilings. The salt discourages insects and vermin.

WOOL... R-value 5.5...Positive features: High R-value. Fire resistant. Will not settle. Negative features: Not available in all areas.

LEAVES... R-value N/A... Positive features: Available. Inexpensive. Negative features: Must be protected from vermin and fire. Must be very dry.

SAWDUST... R-value N/A... Positive features: Good sound proofing. Negative features: Must be very dry. Must be protected from vermin, termites and fire. May settle.

CARDBOARD...R-value N/A...Positive features: Available. Inexpensive. Can be used as sheathing to cut down on conduction. Negative features: Flammable. Must be protected from fire, vermin and moisture.

RAGS...R-value N/A... Positive features: Inexpensive. Available. Negative features: Rags must be clean and dry. Must be protected from fire and vermin. Synthetic rags less likely to rot or attract vermin.

DIRT...R-value low... Positive features: Universally available. Will not burn. Negative features: Must be very dry. Because of its poor R-value, must have thick walls to be effective. Heavy.

WOOD...R-value low...Positive features: Available in many areas. Wood buildings are attractive. Negative features: Expensive. Because of poor R-value, walls must be thicker. (Consider cordwood building.) Must be protected from fire, insects (termites) and moisture.

PLASTIC BAGS AND WRAPPINGS...R-value 3 - 4... Positive features. Inexpensive. Available. Will not settle. Not effected by moisture. Negative features: Must be protected from fire. Creates toxic fumes while burning. Must be clean.

ASHES...R-value N/A...Positive features: Will not burn. Can be used to insulate heat sources such as fireplaces, woodstoves, cookstoves and chimneys. Negative features: Must be carefully screened to remove any burnable charcoal. Must be kept dry.

THERMAL MASS

What It Is

Thermal mass is any material that can be used to moderate temperatures in a passive solar structure.

Types of Thermal Mass

Water provides excellent thermal mass. Use two to four gallons of water per square foot of glass.

Types of Thermal Mass

Dense materials such as concrete, stone, brick and block will moderate temperatures. Use two cubic feet of these materials for each square foot of glass.

Note: Without thermal mass, a passive solar home can become uncomfortably hot during the day and uncomfortably cold at night.

Note: Thermal mass must be combined with insulation to be effective.

Concrete, stone, brick and block are popular materials in many countries. Without insulation, these materials often create living structures that are too hot in the summer (particularly at night) and too cold in the winter. Once these high mass materials are cold all the way through, they stay cold. When they are hot to the core, they will radiate heat all night long.

Note: Earth-Coupling is another technique for moderating temperatures. An example of earth-coupling is a basement wall. The earth against the wall moderates temperatures in the basement.

Calculations for Passive Solar Dwellings

NOTE: These calculations are rough guidelines. As you live in your home you will be able to fine-tune your passive solar dwelling by adding or subtracting glass or mass.

1. Calculate the square footage (L x W) of the home.
2. To calculate how much glass you should have multiply the square footage of the home times 17-22%.
In colder climates use the higher percentages.
3. Calculate the square footage of all your glass. Measure just the glass, not the window frames.
4. If you use water for thermal mass, use 2 to 4 gallons per square foot of glass.
5. If you use concrete, stone, brick, etc. for mass, use 2 cubic feet for each square foot of glass.

Reference Note:

Some of the best examples of passive solar dwellings can be found in *The Passive Solar House* by James Kachedorian.

DESIGN CONSIDERATIONS

Answer the following questions:

1. What is the average rainfall on the building site?
Does the rain fall in just one month? ...two? ...year round?
2. How many days will the sun shine on your site?
3. Will trees block the sunshine from your Ark?
4. What are the wind conditions?
5. What type of vegetation is on your site?
trees...grass...cacti, etc.
6. What materials are available?
7. What materials are used in the construction of local houses?
8. How are local houses designed?
9. What type of soil is on your building site?
rocky...sandy...heavy clay...loam...sandy loam
10. What is your elevation above sea level?
11. Is your land flat? ...steeply sloped? ...both?
12. How much money do you have for your Solar Ark?
13. How much does local labor cost?
14. Is there anyone in the neighborhood who has a good reputation building houses?
15. How far will you have to go for materials?
16. Do you have a vehicle that can carry your materials?
17. Do you have the tools needed to build your Ark? Are any tools available in your community?
18. Do you own or rent your property?
19. Should your Ark be moveable?

KEEPING COOL!

Comfort in Hot Climates

(A cool missionary is a happy missionary!)

BUILDING DESIGNS FOR HOT CLIMATES

1. Buildings on stilts to maximize air movement. (Particularly suitable for wet climates.)
2. Superinsulated buildings such as strawbale structures. Consider aluminum foil or mylar when insulating.
3. Earth-coupled buildings such as Earthships and bermed structures.
4. High-mass buildings such rammed-earth structures, concrete construction and cob construction.
5. Combinations of the above options.

MAXIMIZING AIR MOVEMENT

Maximum air movement = maximum cooling.

Place fans as close as is safe to your body. The closer you place the fan to your body, the greater will be its cooling effect. Place the fan so that it will not dry out your eyes, nose and throat, making you susceptible to sinus infections. By placing the fan close to your body you may be comfortable with a small fan that will use less electricity. If you must sleep under a mosquito net, put your fan inside the net.

Design your living space so that the air will be moving at maximum velocity over your bed.

To maximize air flow through windows reduce the size of the inlet to half of the outlet area. Also, place the exhaust window high on the leeward side of the building and the intake window low on the windward side. See illustration below.

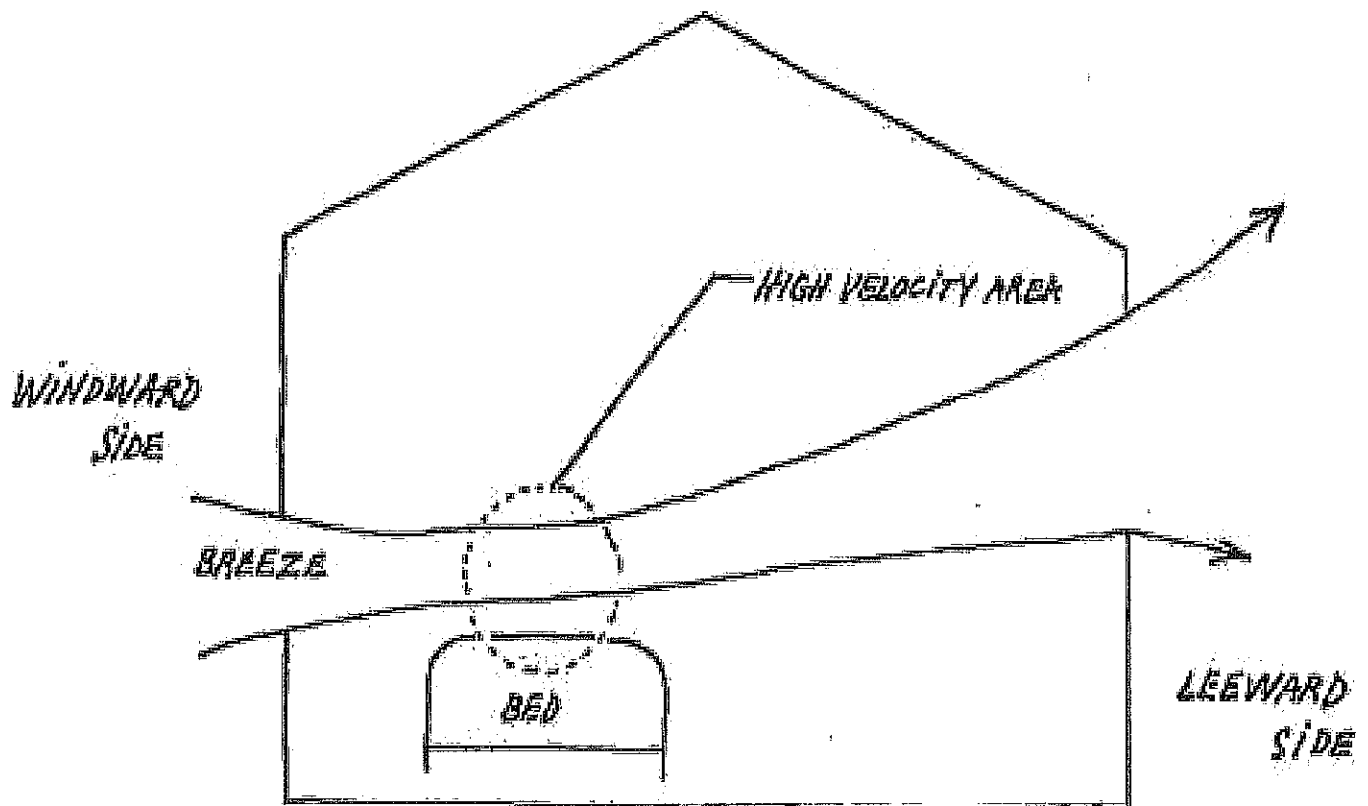

SOLAR COLLECTOR - BIOMASS HEATER WITH ROCK STORAGE

Origins:

The Solar Collector - Biomass Heater w/ Rock Storage (SCBH) is a refinement of several ideas including the Trombe Wall and James Kachadorian's Solar Slab. The addition of a wood stove makes the SCBH an excellent choice for areas with heavy winter cloud cover.

Operation:

The SCBH operates much like a Trombe Wall. When the rays of the sun pass through the glazing and strike the absorption plate, hot air is created. As the hot air rises, cool air is drawn into the hot air chamber. Using a fan to increase air movement in the SCBH may or may not be a good idea. Fans can move air too quickly to allow heat exchange. Using a fan in the living space may be useful to distribute heat. The concrete blocks in the bottom of the SCBH are spaced an inch apart so that warm air can rise through the bin of rocks. If more heat is needed the wood stove can be fired. The stove operates more efficiently because its heat is stored in the rocks. The stove operates more cleanly because it is allowed to burn "hot" with lots of air, which creates more complete combustion. The stove should seldom be dampened. Because the stove access is outside, the mess of wood burning is eliminated. On very cold nights the insulated covers must be placed over the glazing to prevent loss of heat and cold drafts. The covers should be in place on warm days to prevent heating. If the insulated access door to the wood stove is opened and the door of the stove is opened, cool, night air can lower the temperatures in the rock bin to provide cooling.

Vents:

When the vents are open the natural convection in the living space will allow the rock storage to be heated. Cool air will be taken from the floor of the living space. Warm air will enter the living space through the top vents. Like the Solar Slab the temperatures of the rock storage will be just a few degrees above the comfort zone.

Modifications:

If there are not enough sunny days where the SCBH is to be built, the solar collector can be eliminated.

A hot water tank can be placed in the rock storage bin for winter operation. Care must be taken to prevent freezing.

Calculations:

NOTE: These are rough calculations. Using passive solar is an art. Some adjustments may be necessary.

The size of the SCBH is calculated in the following way:

1. Calculate the square footage of the structure to be heated.
2. Multiply the square footage of the home by 17% to 22%. This is the square footage of the glazing required. [In warmer climates use 17% to 18%. In cooler climates use 20% or 22%.]
3. To find the amount of rock required, multiply the number of square feet of glazing by 2.25. The resulting figure is the number of cubic feet of rock required.
4. **CALCULATING VENT SIZE:** Multiply the square footage of the glazing by 3%. The resulting figure is the total square footage of the vents on the wall of the SCBH that adjoins the living space. The vent area should be distributed evenly between upper and lower vents. There will also be the same number and size of vents in the absorption plate. The vents should not be directly in line with one another, either horizontally or vertically. More effective airflow is created by the uneven spacing of the vents.

Notes:

1. Glazing should be of tempered glass or fiberglass, which will withstand higher temperatures than standard glass. The frame which holds the glass should be wood or metal. Vinyl is not a good choice.

SOLAR COLLECTOR - BIOMASS HEATER W / ROCK STORAGE

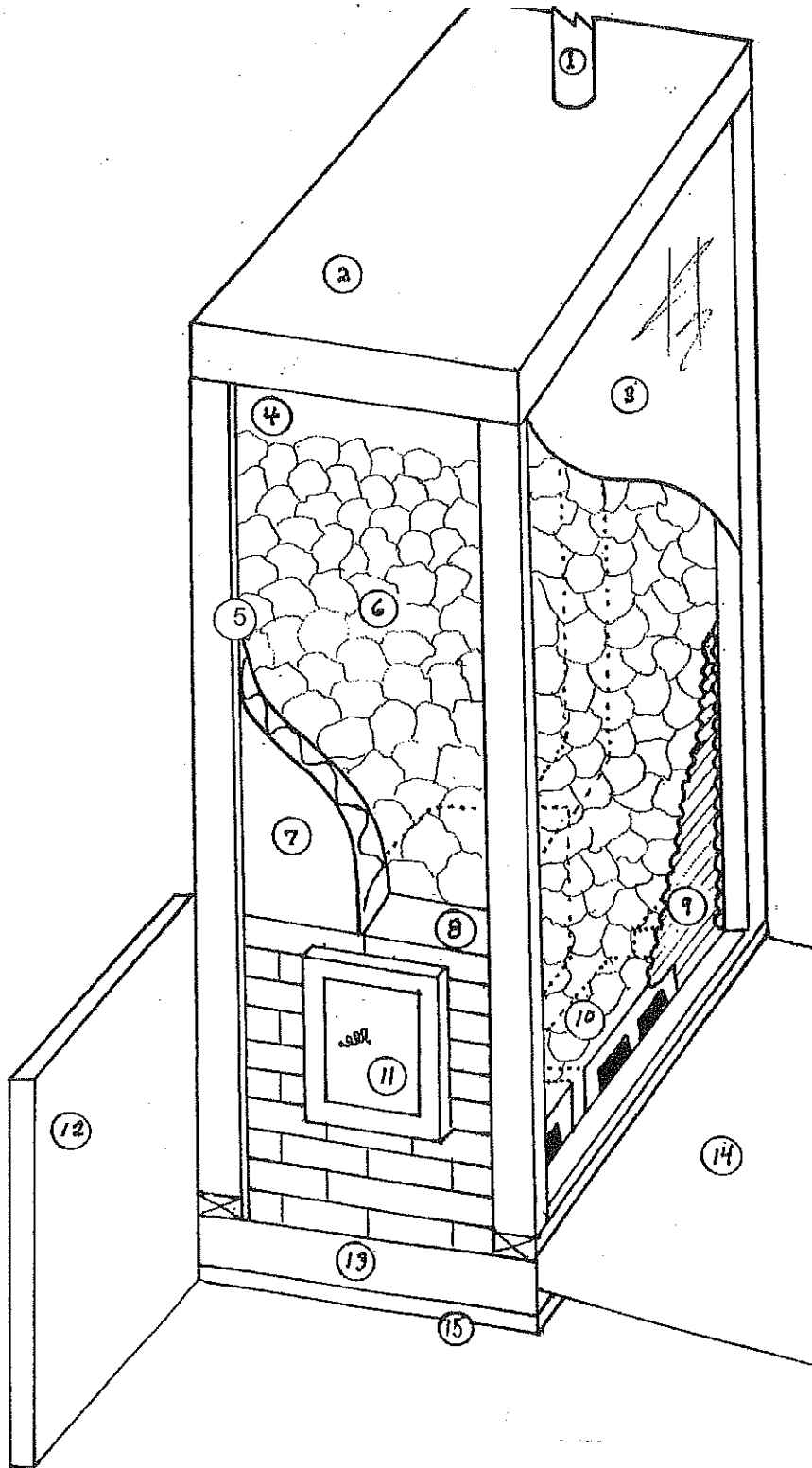

CALL LIST:

1. Chimney and stovepipe made of heavy steel pipe so that it will not have to be replaced.
2. Insulated roof.
3. Tempered glass or fiberglass.
4. Open space for air flow.
5. Wall of living space.
6. Fist-sized rock. Clean and uniform in size.
7. Insulated wall. Box is super-insulated.
8. Brick or block hip wall.
9. Solar absorption plate. Corrugated steel, painted black.
10. Concrete block, on its side to create a vent.
11. Box woodstove.
12. Insulated, fireproof door.
13. Concrete slab.
14. Insulated cover for solar collector.
15. Two-inch rigid insulation.

SOLAR COLLECTOR – BIOMASS HEATER W/ ROCK STORAGE

Detail of Construction and Air Flow

2008 JACK DODY

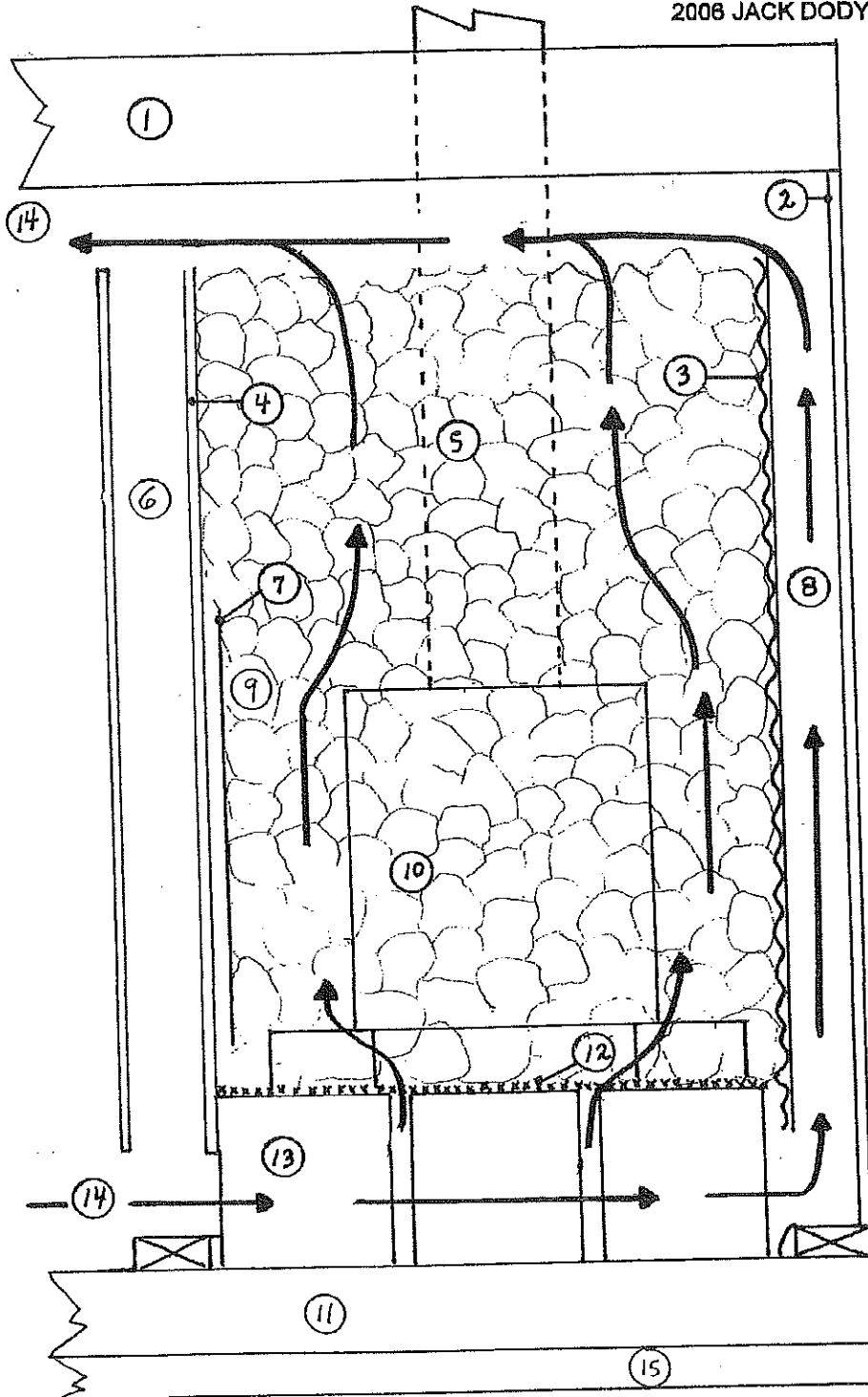

CALL LIST:

1. Insulated roof.
2. Tempered glass or fiberglass
3. Solar heat absorption plate. Corrugated metal painted black.
4. Sheathing
5. Stove pipe
6. Wall to living space
7. Metal heat shield
8. Hot air chamber
9. Rock storage
10. Wood stove
11. Slab
12. Heavy hardware cloth allows warm air to filter through rocks
13. Concrete blocks on their sides to create air passages. Blocks are spaced one inch apart to allow airflow upward.
14. Openable vents to living space
15. Rigid insulation

VENT PIPES

- Use clay or PVC pipe.
- Pipe must be smooth, not corrugated.
- Pipe must drain to inside or outside. It must hold no standing water that would encourage the growth of mold.
- Pipe must be screened on both ends to prevent vermin from making their homes in the pipe.
- Pipe is buried at depths which remain constant in temperature. Depth will vary with locale, usually 3 to 7 feet. If it is not practical to bury the pipe deeply, the pipe will still function when buried less deeply. Some efficiency will be lost.
- One square foot opening of pipe for every 100 square feet of living space is minimal. Twice that amount is optimum.
- Vent pipes must be coupled with fans, windows or solar chimneys to create air flow. It is important that the air moves slowly through the pipe. If the air moves too quickly through the vent pipe, the efficiency of temperature transfer will be reduced.

HOW IT WORKS

in warm weather, air from outside is cooled as it passes through the pipe, helping cool the living space. In cold weather, air is warmed as it passes through the pipe, providing preheated fresh air.

EXAMPLES:

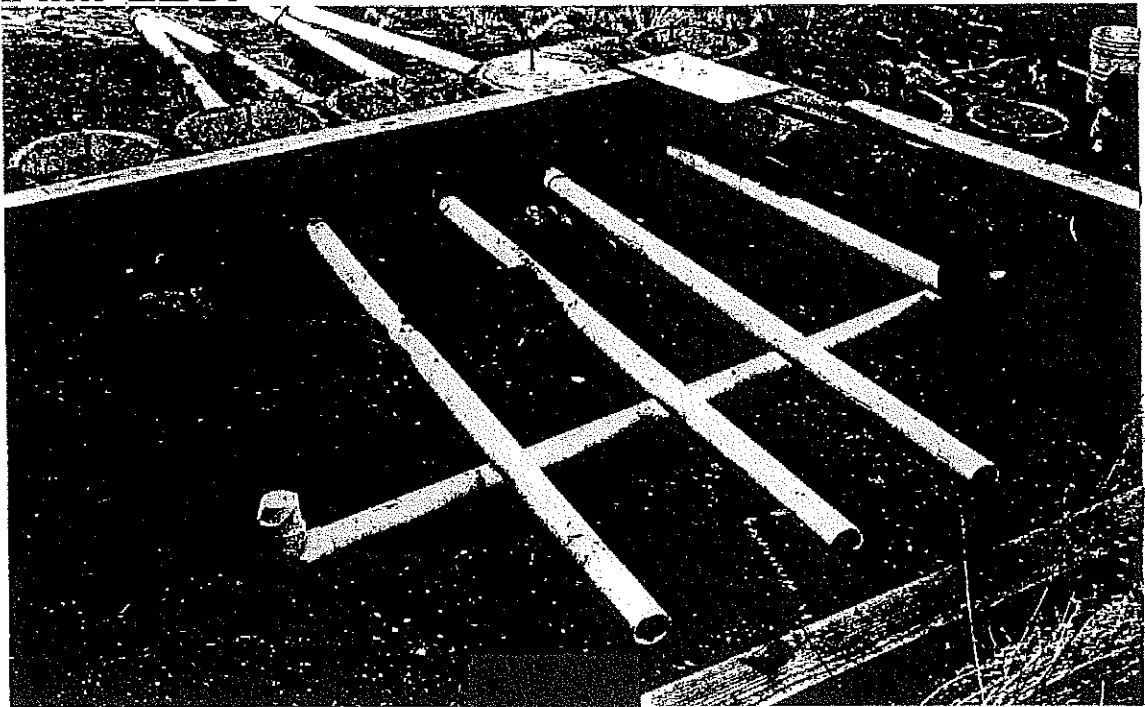

VENT PIPES FOR A LEVEL BUILDING SITE

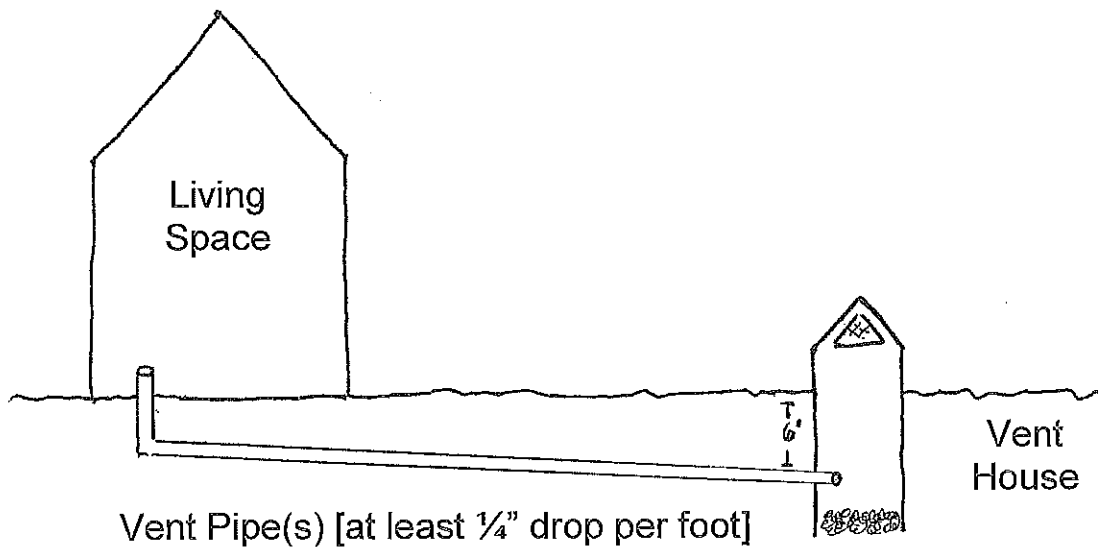

Notes:

- Vent house has an open bottom lined with six inches of gravel.
- Vent house is screened to provide maximum air movement and to prevent the invasion of insects or vermin.
- Vent house should be seven to ten meters from the living space.

SHADE

It is hard to overestimate the positive effect of shade in keeping your dwelling cool. Unfortunately, it may be a scarce commodity where you live. It may also interfere with your photovoltaic panels if you are making your own electricity.

Here are some solutions:

1. Plant some trees - today.
2. Spend time laying out your homestead. Watch the path of the sun. Watch shadows. Consider using trees for a windbreak if applicable. If you are collecting rainwater from your roof, make sure your dwelling is far enough from trees so that the roof is not contaminated with leaves or bird droppings.
3. If you have PV panels, consider mounting them on a pole away from your dwelling. (Not too far, resistance in wire will cause voltage to drop.) PV panels may be more secure from theft when mounted on your roof.
4. Consider using a tarp like a tent fly to create shade over your dwelling. Be sure fly is large enough to shade all sides of the living structure. An inexpensive silver, poly tarp will reflect lots of heat. A more expensive sun screen cloth will allow air to pass through and will allow some view. The fly should not cover PV panels or solar heaters.

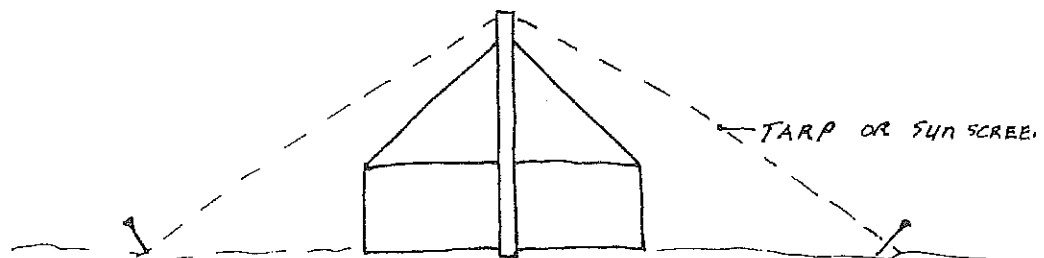
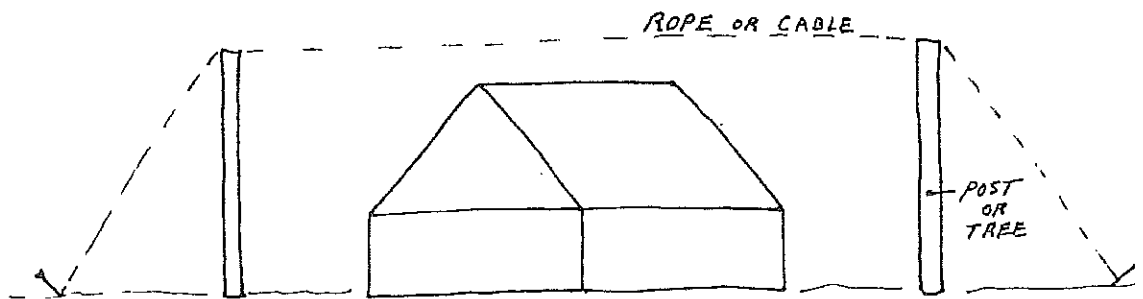

TWELVE-VOLT FANS

NOTE: Inverters do not like AC ceiling fans. They will be noisy and inefficient. Use DC ceiling fans.

Our Most-Efficient DC Ceiling Fan

For keeping comfortable with a 12- or 24-volt power system, you can't beat the efficiency and quiet operation of our 42" diameter DC ceiling fan. It comes with both a close flush-mount for flat ceilings, or a down rod ball-mount for sloped ceilings. The fan can be assembled with either four or five blades, showing either walnut or oak finish (five blades included). The fan body is a charcoal-gray ABS injection casting that can be painted to match or left stock. Reversible and speed-adjustable using the solid-state controls sold below. Close mount hangs down 9.5"; down rod needs 13"

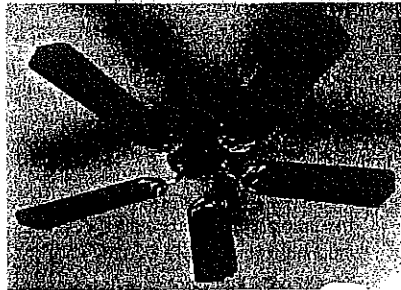

Performance specs; at 12 volts: 60 rpm, 4.8 watts, 1,800 cfm; at 24 volts: 120 rpm, 19.2 watts, 4,000 cfm. Note that performance is ... um ... modest at 12 volts. 12-volters may be interested in the 12 to 24 voltage doubler speed control sold on the next page. Fan weight 11 lb. USA.

64-495 RCH DC Ceiling Fan \$199

Vari-Cyclone DC Ceiling Fan

The Vari-Cyclone utilizes revolutionary "Gossamer Wind" blade design technology that delivers 40% more air flow without any increase in power use. Intended for 12- or 24-volt off-grid DC power systems, this 60" diam-

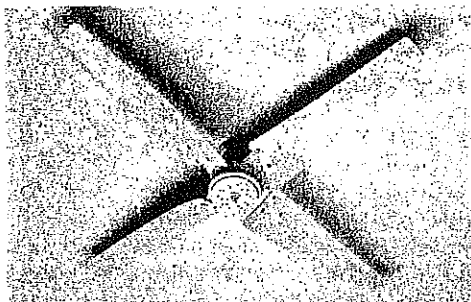

eter fan can be assembled with either three or four blades. Finish of blades and body is white. Can be mounted as either a close flush mount for flat ceilings, or with a down rod ball mount for sloped ceilings. Hardware is included for both. Close mount hangs down 9.5", down rod takes 13". Fan becomes variable speed and reversing with addition of 12- or 24-volt solid state control listed below.

Performance specs (with 3-blade configuration): At 12 volt: 60 rpm, 7 watts, 2,500 cfm. At 24 volt: 120 rpm, 27 watts, 3,400 cfm. We recommend the voltage doubler adjustable fan speed control below for 12-volt use. Fan weight approximately 14 lbs. USA.

53-0100 Vari-Cyclone DC Fan \$279

Noisy, poorly made 12-volt fans will not last. On the following pages are high-quality fans that will last. The first page is from Real Goods. (Realgoods.com)

12V Fans

These 12VDC axial fans are ideal for moving woodstove heat throughout the house. The brushless motor design minimizes electromagnetic interference and radio frequency (rf) interference. The fans have PBT plastic housings with permanently lubricated ball bearings. All motors are polarity protected. The voltage range for the nominal 12VDC fan is 6 to 16 VDC. The two smaller fans are 1 inch in depth and the larger fan is 1½ inches deep. Size shown is square.

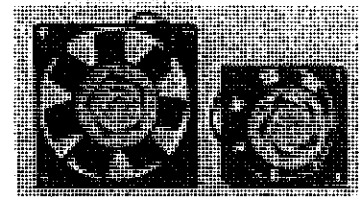
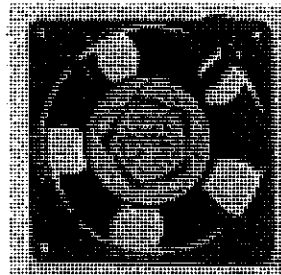

64-211 4C909 15cfm 0.24amps 2-3/8" \$42
 64-212 4C911 32cfm 0.25amps 3-1/8" \$42
 64-213 4C918 105cfm 0.55amps 4-11/16" \$45

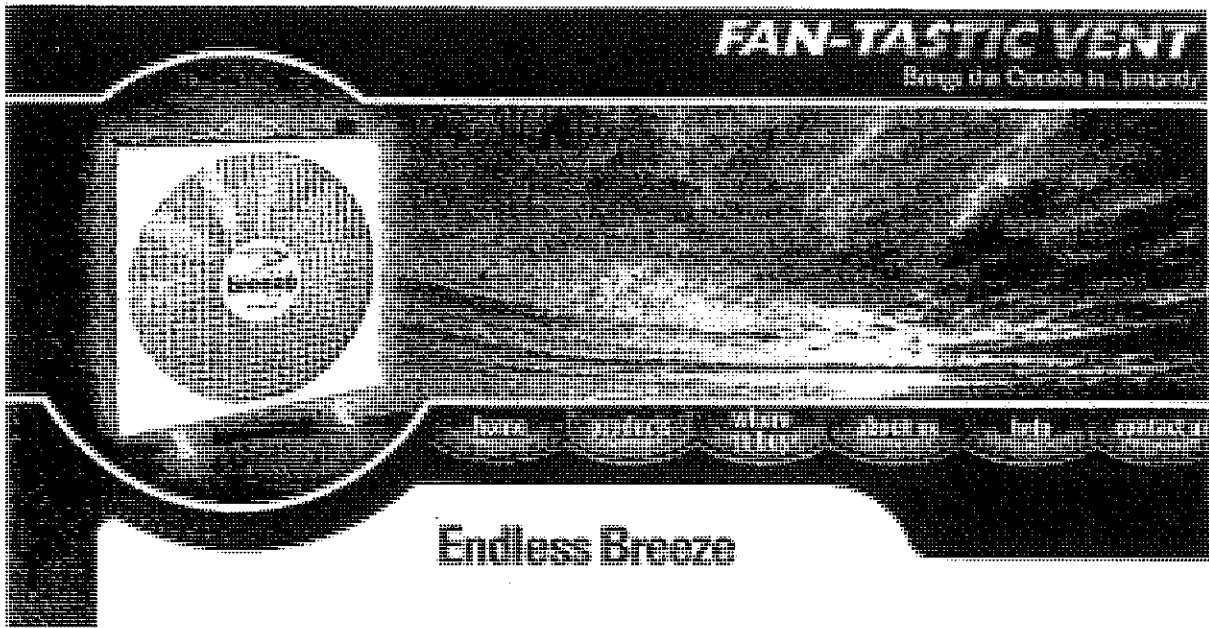

Endless Breeze

"Endless Breeze" a powerful portable 12 volt fan. Endless Breeze is a high volume 12 volt fan with a twelve inch blade that operates at three speeds. Air movement of up to 900 CFM (cubic feet per minute) introduces a major breakthrough in 12 volt portable fans. Portable it is! Standing only fourteen inches tall on retractable legs and less than four inches deep it travels and stores easily and weights under five pounds. Endless Breeze can be powered by any 12 volt power source such as automotive lighter outlets or connecting jumpers to any 12 volt battery. Maximum current draw is three amps. Equipped with a 12 volt plug and cord. The uses for Endless Breeze are literally endless! Boats, tents, campers, sleeper cabs, horse trailers, power failures and the family car, van or SUV are a few of many applications. "We've had customers tell us they have used them to blow the bugs away on hot muggy nights or even help thaw out the RV refrigerators," said Dave Struck, Fan-Tastic's Vice President of Sales and Marketing. Endless Breeze 12 volt fans will be available through mass marketers, specialty stores and specialty catalogs.

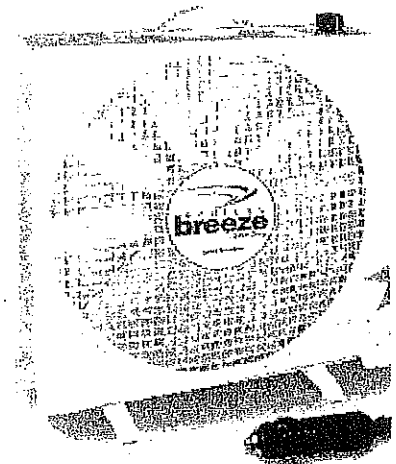

Web address: Fantasticvent.com

For a larger view please download the PDF version

FAN-TASTIC VENT

Brings the Outside in... Instantly

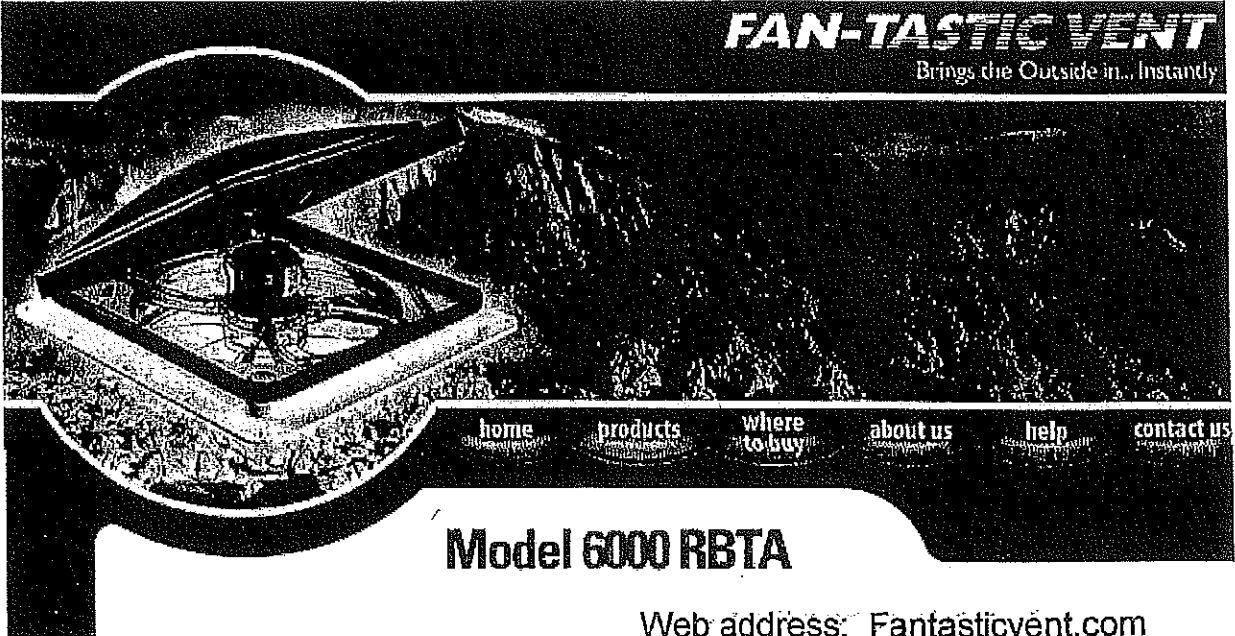

home

products

where to buy

about us

help

contact us

Model 6000 RBTA

Web address: Fantasticvent.com

Select speed (1-low, 2-medium or 3-high). Placing the IN/OUT switch in the center (neutral) position can turn off fan blade. Automatic Dome Opener with Built-In Rain Sensor. This model is activated when the three-speed switch is turned to any of the three speed selections. The dome cover is opened when the dome up switch is activated and closed when the down feature of the switch is selected. To activate the fan blade, the built-in thermostat must be turned to a temperature selection, which is lower (cooler) than the current interior temperature. Once the selected temperature is attained, the fan blade will shut off, but the dome will remain open until the down feature is selected or the built-in rain sensor becomes wet. Once the sensor dries, the dome will re-open. A built-in manual knob can be used to close the dome in an emergency, to adjust the dome to a desired partially open level or to override the rain sensor. For storage, the dome switch must be in the down position and the three-speed switch in the off ("O") position.

Technical Information:

- Durable, proven longevity
- Quiet, 12-volt ceiling fan with 3-speeds
- Lexan dome/Lifetime guarantee
- Removable screen for easy cleaning
- Reversible fan blade motor (in or out)
- Low AMP draw insures full-time use
- Optional insulated dome. Please call for informaion.

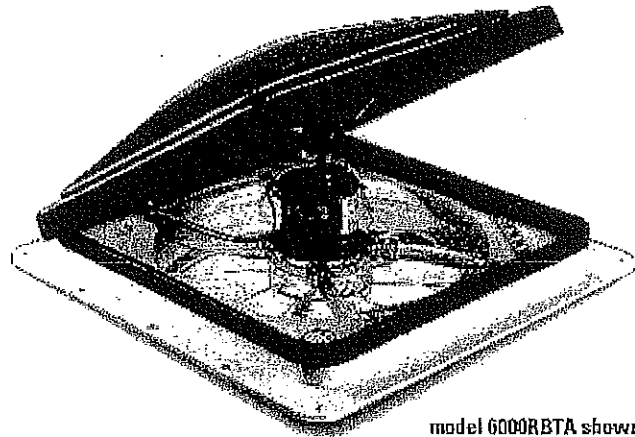

model 6000RBTA shown

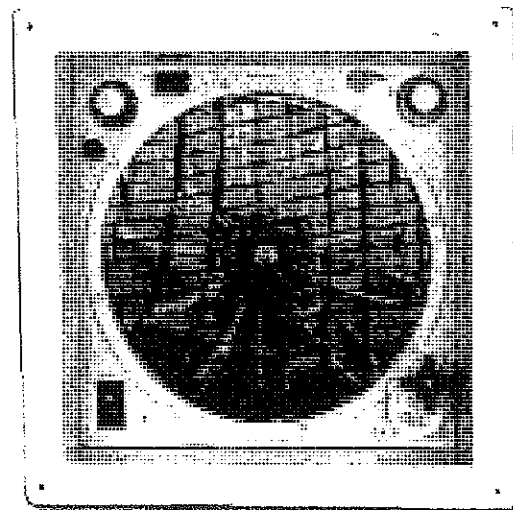

model 6000RBTA bottom shown

PORTABLE PLUS

**INDOOR FAN
OUTDOOR FAN**

BATTERY OR AC POWERED

LE PLUS G. DE L'EFFICIENTE ALTERNATIVE

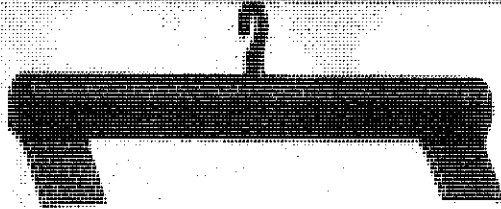

USE IT ANYWHERE

USE IT ANYWHERE

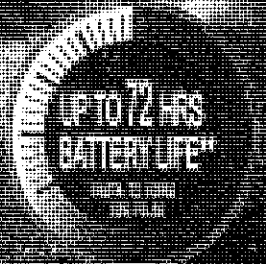
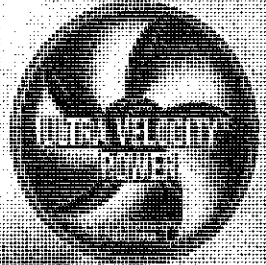
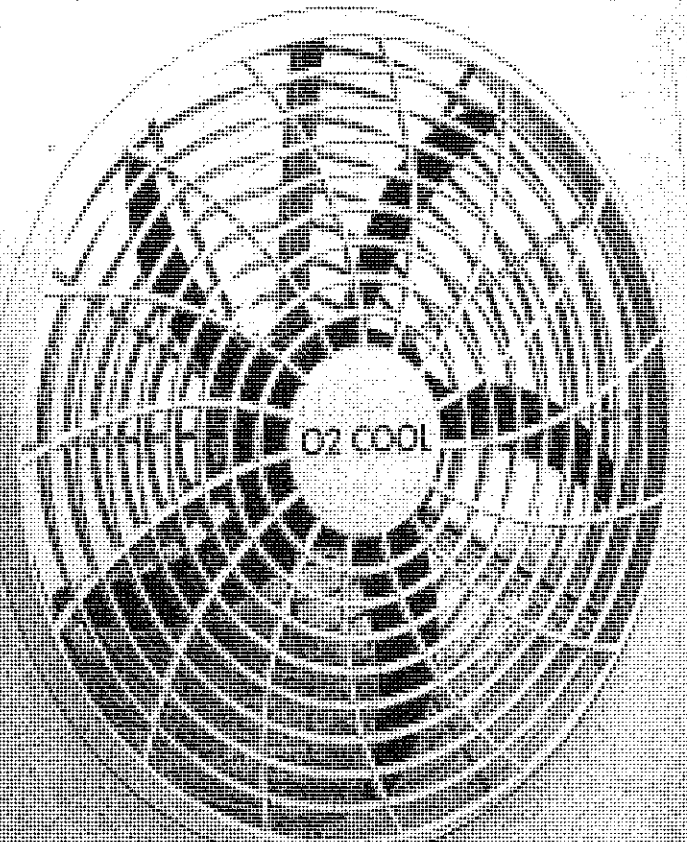

O2 COOL

This fan is available at Walmart for \$12-\$15, plus \$10 for a 12VDC cord. It can be wired to your 12VDC system (2009). Fan uses .3 amps on low and .6 amps on high.



Alternative Choices Solar, Inc.
solar and wind power specialists

1-800-784-3603

Note: This is a bid from
2002 showing options
for powering fans.

Jack Dody
PO Box 26
Rush, CO 80833
719-471-4231

ITEM	DESCRIPTION	#	PRICE	TOTAL
OTB	12 volt Oscillating Table Fan	1	\$ 38.00	\$ 38.00
PW80	Photowatt 80 Watt Modules	1	\$ 346.00	\$ 346.00
SW5	Solsum 5 Amp Charge Controller	1	\$ 39.00	\$ 39.00
T220	Trojan Golf Cart Batteries - 6V 220Amp	2	\$ 75.00	\$ 150.00
BC#2/0	Battery Cables	1	\$ 9.50	\$ 9.50
SUBTOTAL				\$ 582.50
DISCOUNT 5%				\$ (29.13)
TOTAL				\$ 553.38

March 11, 2002
Prices do not include tax, freight, or installation.

PV SPECS: 80Watts @ 17.75V, 4.8 Amps, 25 Year Warranty.
BATTERY STORAGE: 220 Amphours @ 12 Volts.

ITEM	DESCRIPTION	#	PRICE	TOTAL
CF12	12 Volt Ceiling Fan	1	\$ 165.00	\$ 165.00
SW20	Sunwize 20 Watt Module	1	\$ 145.00	\$ 145.00
SW5	Solsum 5 Amp Charge Controller	1	\$ 39.00	\$ 39.00
T220	Trojan Golf Cart Batteries - 6V 220Amp	2	\$ 75.00	\$ 150.00
BC#2/0	Battery Cables	1	\$ 9.50	\$ 9.50
SUBTOTAL				\$ 508.50
DISCOUNT 5%				\$ (25.43)
TOTAL				\$ 483.08

March 11, 2002
Prices do not include tax, freight, or installation.

PV SPECS: 20Watts @ 16.5V, 1.22 Amps, 20 Year Warranty.
BATTERY STORAGE: 220 Amphours @ 12 Volts.

P.O. Box 128
Florence, CO 81226

acsolar@earthlink.net
www.acsolar.com

SMALL IS BEAUTIFUL !

MAXIMIZING THE SPACE THAT YOU HAVE...

Simplify, simplify, simplify...before you go any further, figure out what you really need in your space. Get rid of everything else. No matter what tricks you use to maximize space, if you pack it with too much junk, it will be cramped and cluttered. Consider building a shed for your seldom used stuff that you just can't part with. Think priorities. How do you want to use your space? Do you work at home? Do you entertain? Are you an avid reader with a need for a big, soft chair? Think necessities. Decide which things are essential, which would be great to have, which you can live without if necessary.

Colors can add space...use light colors, cool colors (light blues and greens, buttery yellows). Use tone-on-tone color techniques. Paint furniture and recover with cloth that matches the room's colors. Avoid wallpaper borders and darkly painted moldings in small rooms; they tend to outline the room's dimensions and can make your space seem smaller. Painting moldings and trim a slightly lighter color than the walls can make the room loftier and more spacious.

Eliminate obstructions...the farther you can see into and through a space, the larger it will seem. Arrange furnishings to open up areas of floor. Avoid blocking views to windows and doors. Consider open plans with fewer walls. Low benches, ottomans and armless chairs are good choices.

Bring in more light...banish room darkening shadows by uncovering windows and adding more light fixtures. (L.E.D. lighting will not use very much homemade electricity). Consider cove lighting, up-lights, rope lights, bookshelf lights, etc. Consider skylight, light tubes, clerestory windows and glass blocks.

Use mirrors...mirrors can add sparkle and dimension to any room. Use mirrors for table tops. When you hang mirrors on a wall, make sure they will reflect something you want to see.

Use glass and Lucite...furniture made of these materials will add see-through style.

Use sheer fabrics...for window treatments and tablecloths. Let light shine through while adding softness. Avoid heavy, fancy window treatments that cut out light and make the room feel fussy.

Use larger pieces and accessories...reduce visual clutter by using fewer pieces. Lots of small pieces can make a room look cluttered. Clutter takes up space, lots of space.

Use plain upholstery...cover sofas and chairs with plain cloth rather than vibrant prints. Neutral tones in lighter colors will make the room feel larger.

Use closed storage...to cut down on clutter.

Use smooth surfaces...avoid sharp corners. Round edges of walls and furniture. Use sleek handles, or no handles at all, on furniture and cabinet doors. Avoid gross, bold textures.

Create visual lines...use floor patterns that extend the path of the eye. Let windows take the eye outside. Create a smooth inside to outside transition with plants and ground coverings.

Use one type of wood...for trim and furnishings. Use just a few design materials and colors.

Use simple floor coverings...with monochromatic tones. Wall-to-wall coverings are better than area rugs that break up a room's space. Low pile carpets provide less obtrusive textures. Tile laid on the diagonal fools the eye and makes space appear larger.

Think multi-function...a cedar chest (or other chest) which can be used as storage can also be a coffee table. A kitchen table can also be a desk. A chest of drawers can hold office supplies, linens, CDs or even stereo components.

Use built-in storage...built-ins can be squeezed into any nook or cranny. They often take less floor space than regular furniture.

Think vertical...the most underused space in any room is the two or three feet below the ceiling. Instead of a three or four foot tall

bookcase, think about a seven foot one. Mount shelves high up on walls, over windows and doors, or above kitchen cabinets.

Think about scale...every piece of furniture, every fence, every door and window should be of an appropriate size for your living space.

Be creative with sleeping space...consider lofts, futons, pull-out couches and day beds. Go visit some newer college dorm rooms where beds are often placed above study/eating spaces.

Pare down on clothing...pick two coordinating colors of basics (for instance, navy and tan). Try to have no more than two each of these: pants; jackets; sweaters; skirts; dresses; and two pairs of shoes.

Make outside part of your living space...let your eye be led outside by windows and floor coverings. Let dominant outside colors and designs be used inside to create a transitions. Use decks and balconies.

Use various ceiling heights...to “open” a room.

Use folding doors...or sliding doors and panels and pocket doors.

All of the ideas above were taken from numerous sources. Below is a reading list:

Big Ideas for Small Spaces by Christine Brun-Abdeinour

Compact Living by Jane Graining

Designing for Small Homes by Dylan Landis and Donna Warner

House Beautiful by the editors of “House Beautiful”

Living in Small Spaces by Lorrie Mack

One Space Living by Cynthia Inions

Spaces for Living by Liz Bauwens and Alexandria Campbell

Studio Apartments: Big Ideas for Small Spaces by James Grayson Trulove and Il Kim

Blueprint Small – Creative Ways to Live with Less by Michelle Kodis, Gibbs Smith Publisher, © 2003.

A-House ~ Floor Plan

Scale 1/2" = 1'

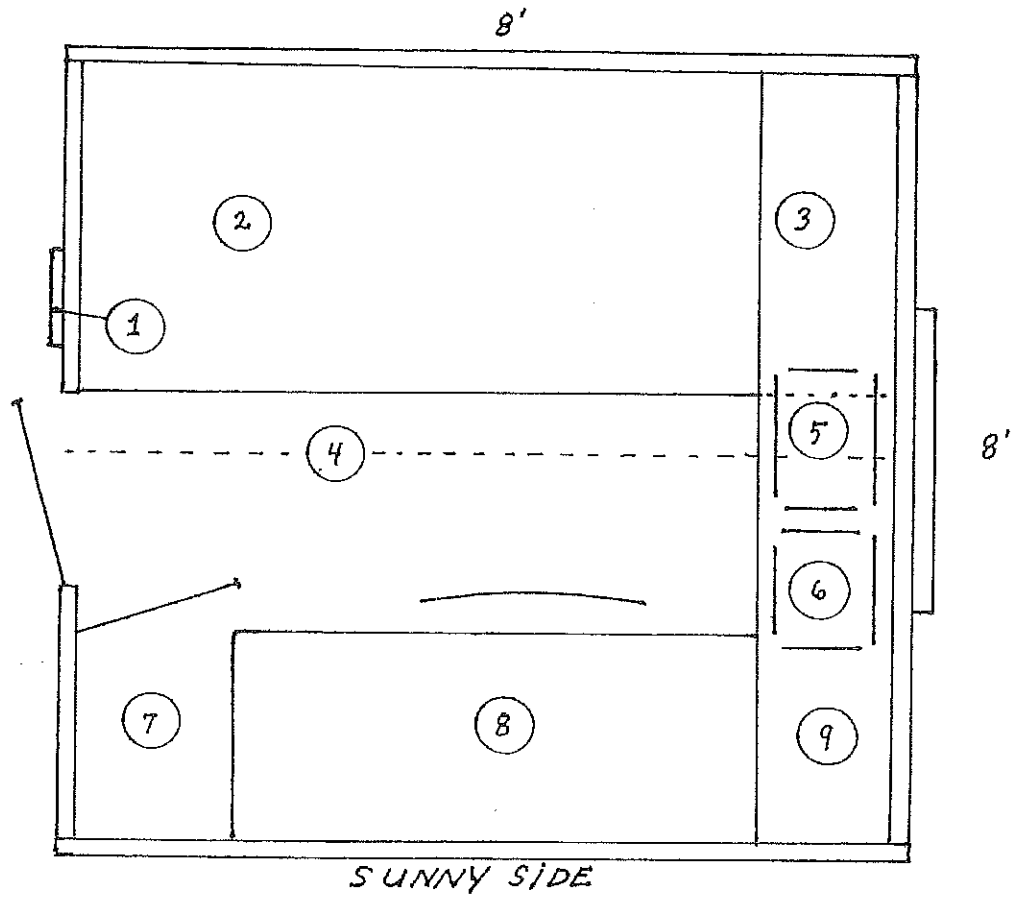

1. Fantastic vent/fan
2. Bed (39" wide) storage below
3. 36" counter (above bed ~ space allowed for feet)
4. Ridgeline
5. Stovetop with cover
6. Sink with cover
7. Closet
8. 30" table/desk ~ storage below
9. Battery storage ~ on floor under desk

A-House ~ E. Elevation

Scale $\frac{1}{2}'' = 1'$

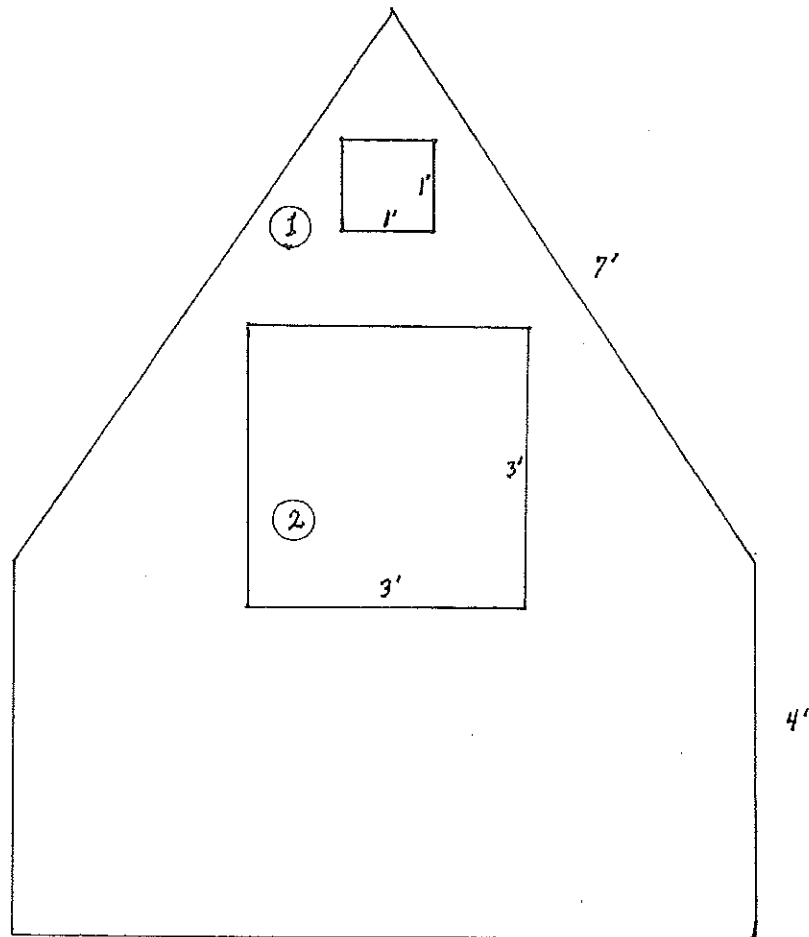

1. Vent / Fan
2. Window

Notes:

- Uses standard 4' x 8' sheathing
- Shape gives sense of openness
- Can be combined with Life Support Module for shower/toilet and woodstove

Arch House

Scale $\frac{1}{4}'' = 1'$

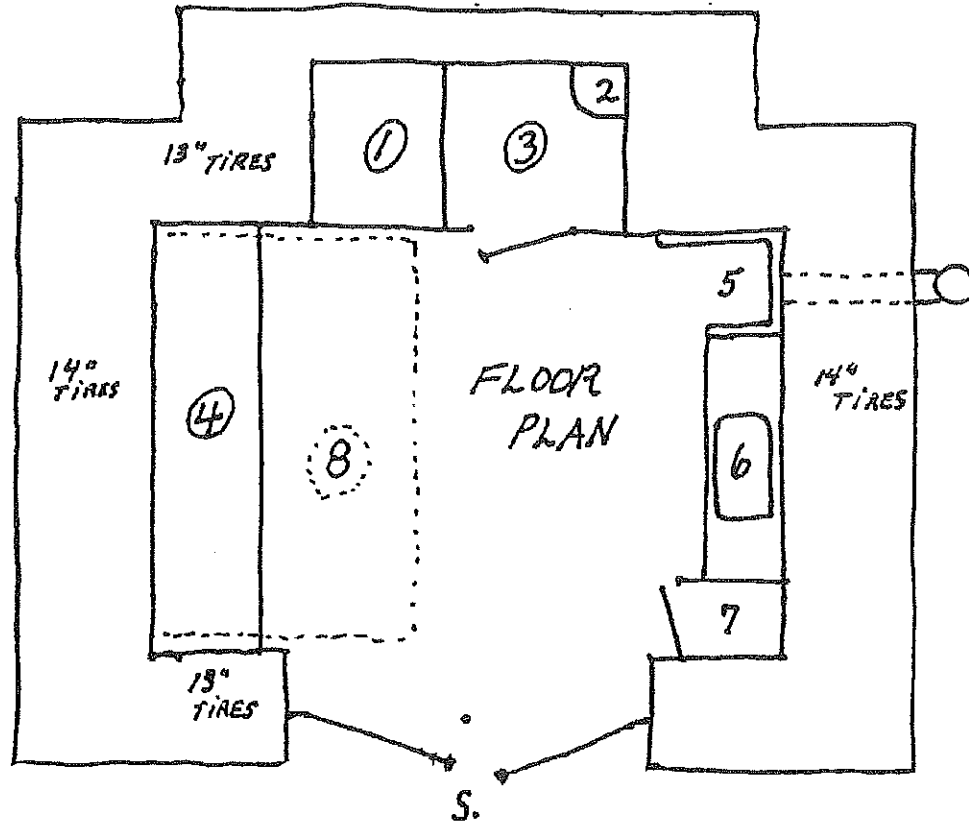

1. Composting Toilet
2. Bath Sink
3. Shower Area
4. Table – Desk – Drawers
5. Fireplace
6. Kitchen Sink
7. Closet
8. Area used when bed is down

The Arch House

S. ELEVATION AND DOOR DETAILS

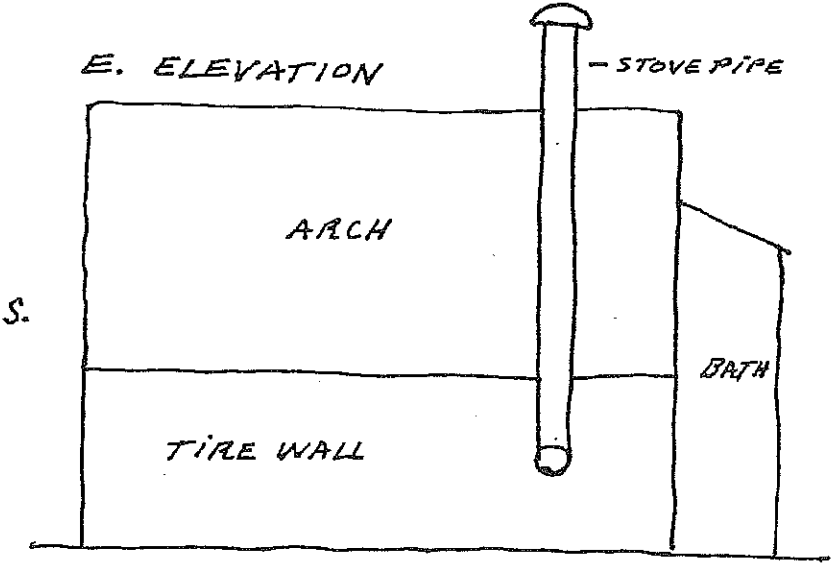
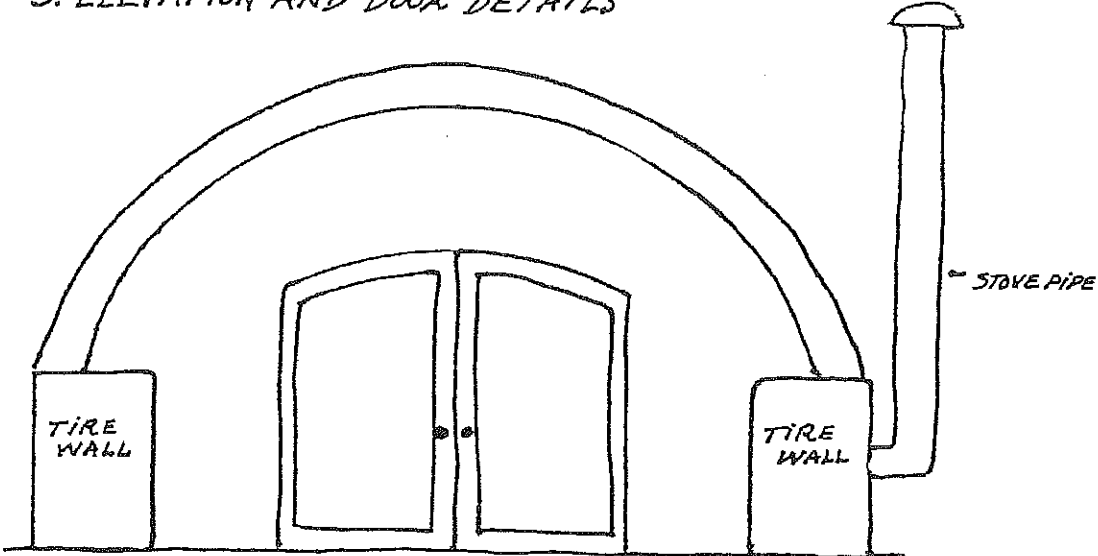

The Arch House

Interior Details

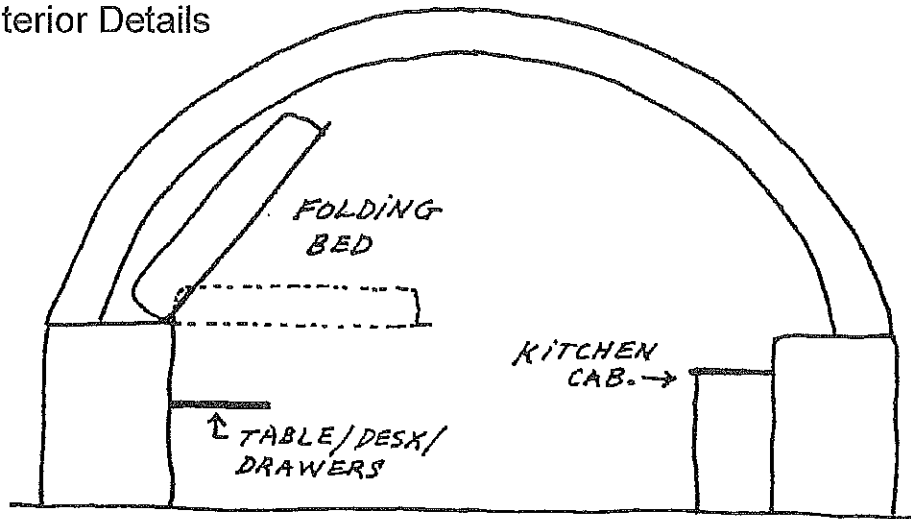

West Wall Interior

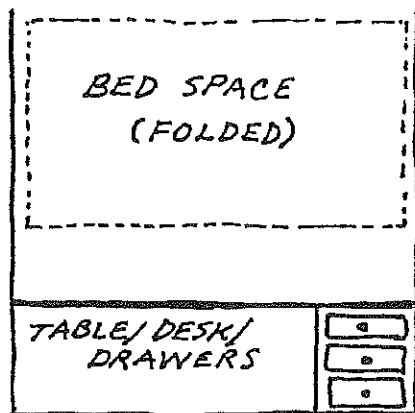

East Wall Interior

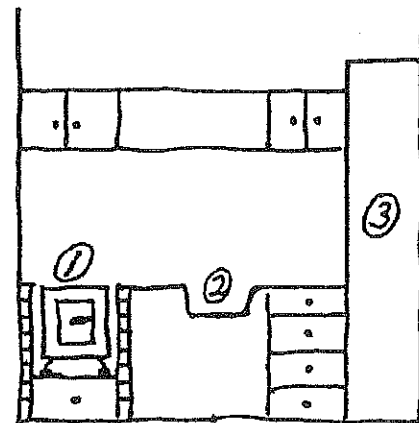

1. Wood burning Stove
2. Sink
3. Closet

The Arch House

Roof Construction Details

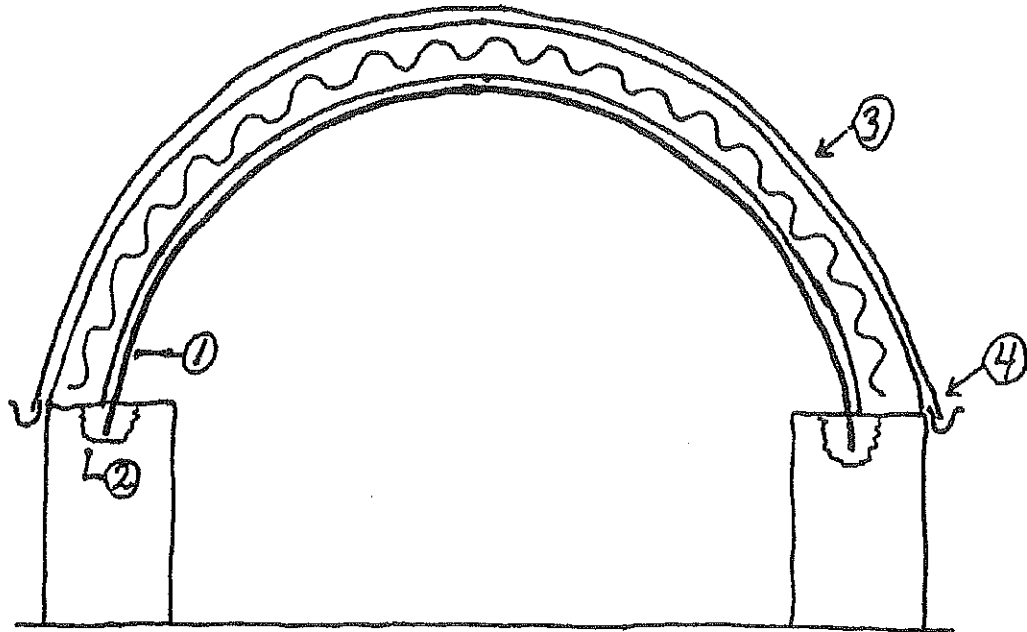

1. Build the arch. Use re-bar, PVC, bamboo, etc. The arch components are 20' long.
2. Set arch in concrete.
3. Create roof quilt. Use three silver, poly tarps. Silver tarps will last longer in the sun's ultraviolet light than other colors. It also reflects heat. Infill the roof quilt with at least 12" of insulative material.

Detail of Roof Quilt -

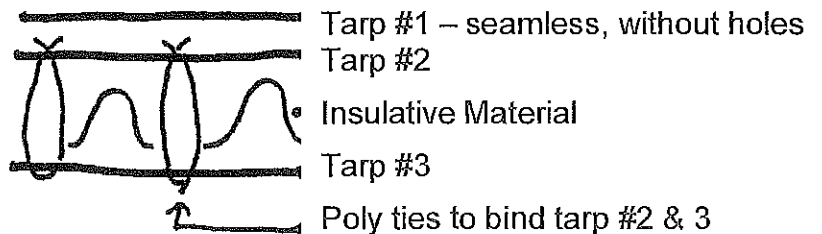

Note: You will need a very large needle to tie tarps together.

4. Tarp #1 is the last to be installed. It must overlap the rain gutters so that all rain is captured.

The Loft House ~ Floor Plan

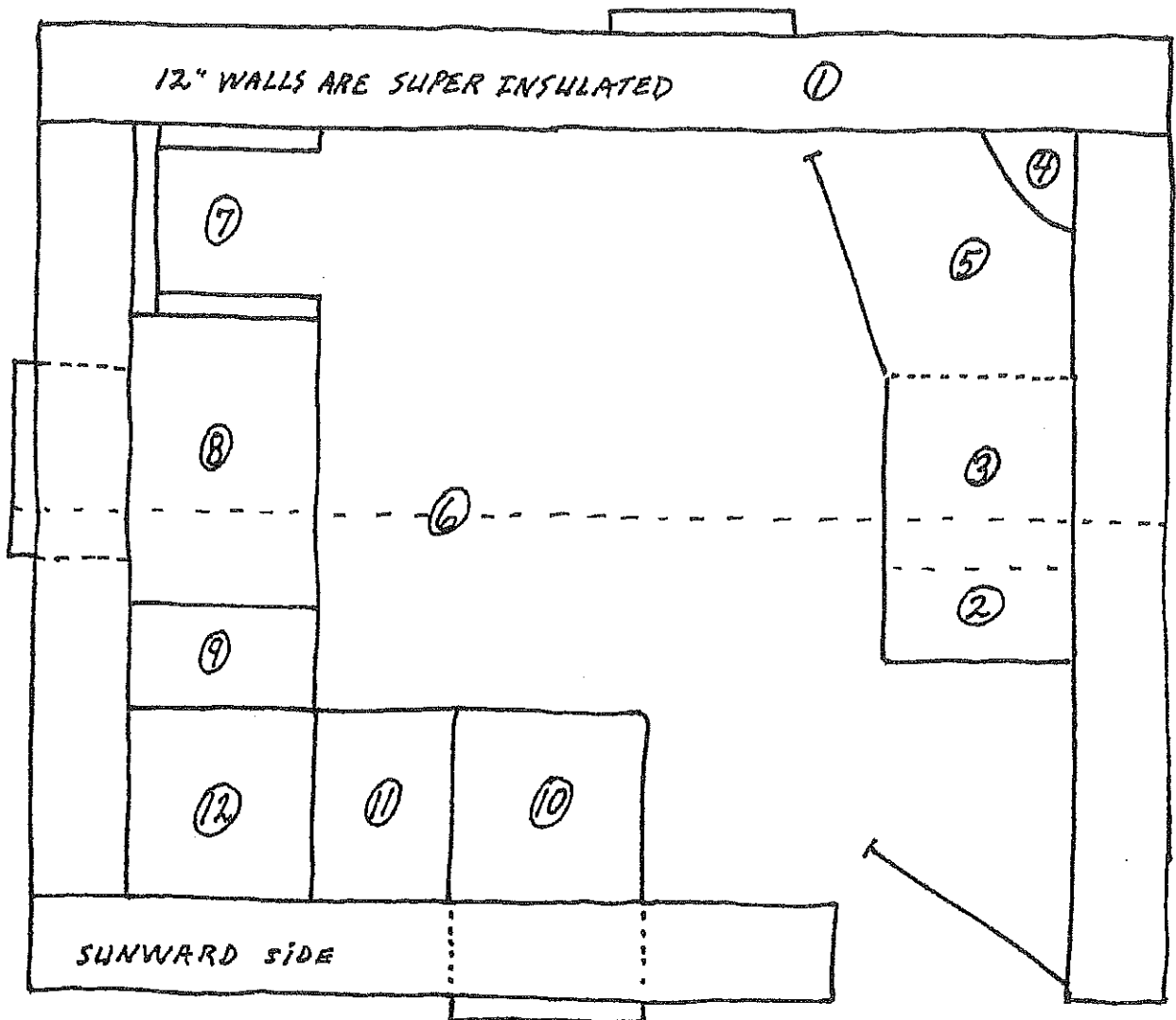

- | | |
|--|--------------------------------|
| 1. 12" Walls | 8. Double Sink |
| 2. Ladder to Loft | 9. Shelf Area |
| 3. Composting Toilet | 10. Table Area |
| 4. Bath Sink | 11. Closet – floor to ceiling |
| 5. Shower Area | 12. Storage – floor to ceiling |
| 6. Roof Ridge Line | |
| 7. Wood Stove with metal cover to extend cabinet space | |

The Loft House ~ Elevation

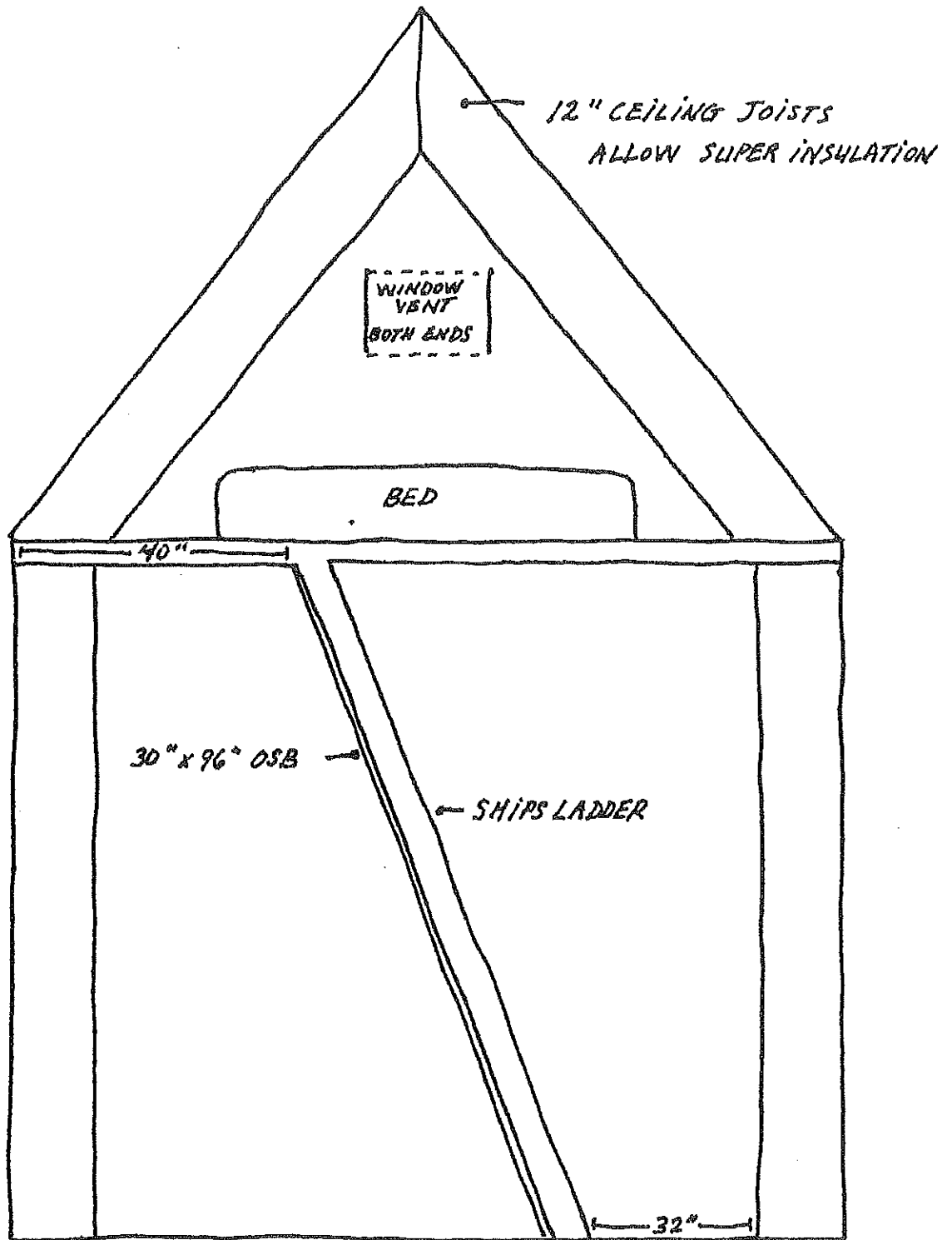

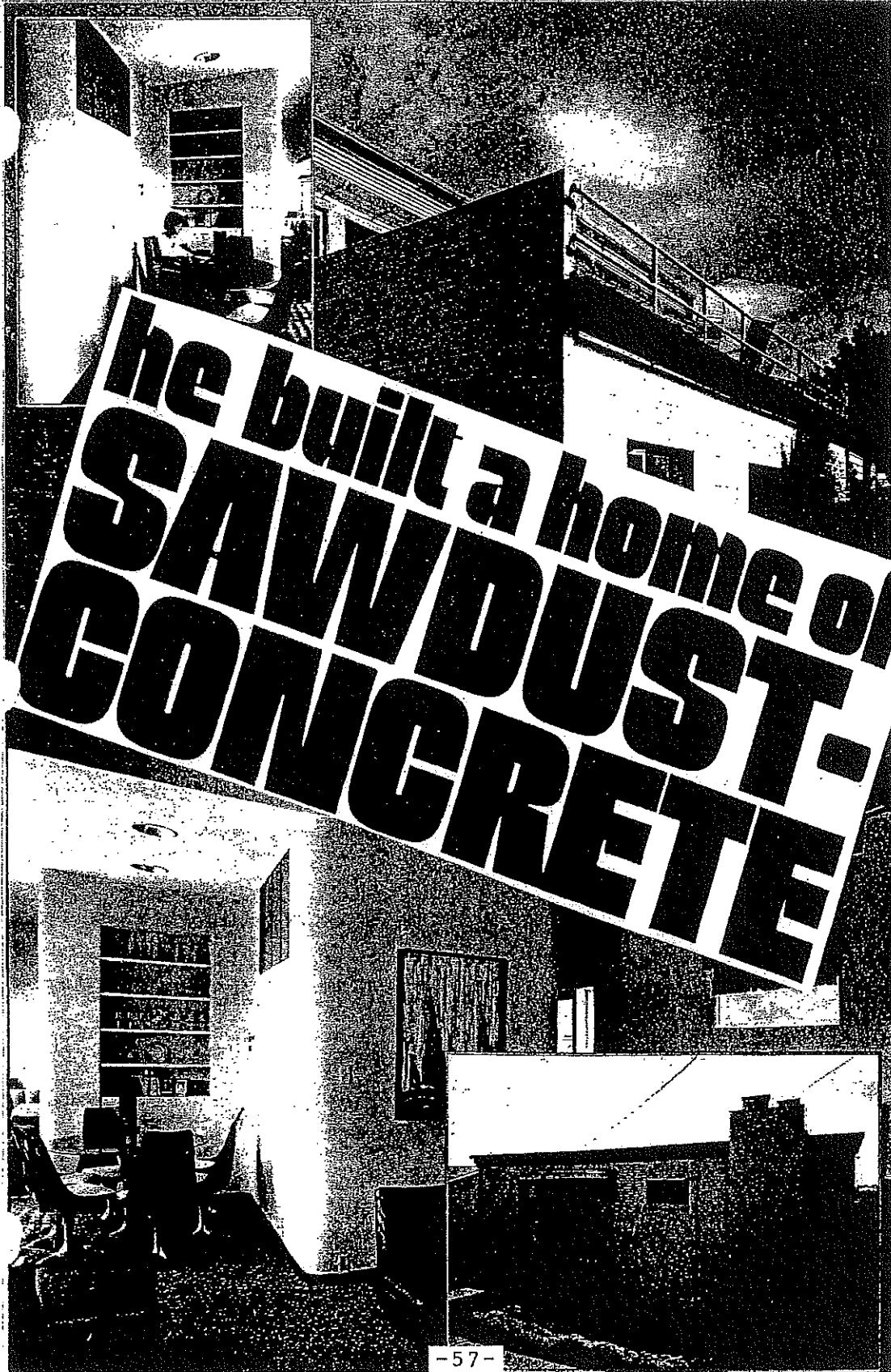

He built a home of
**SAWDUST
CONCRETE.**

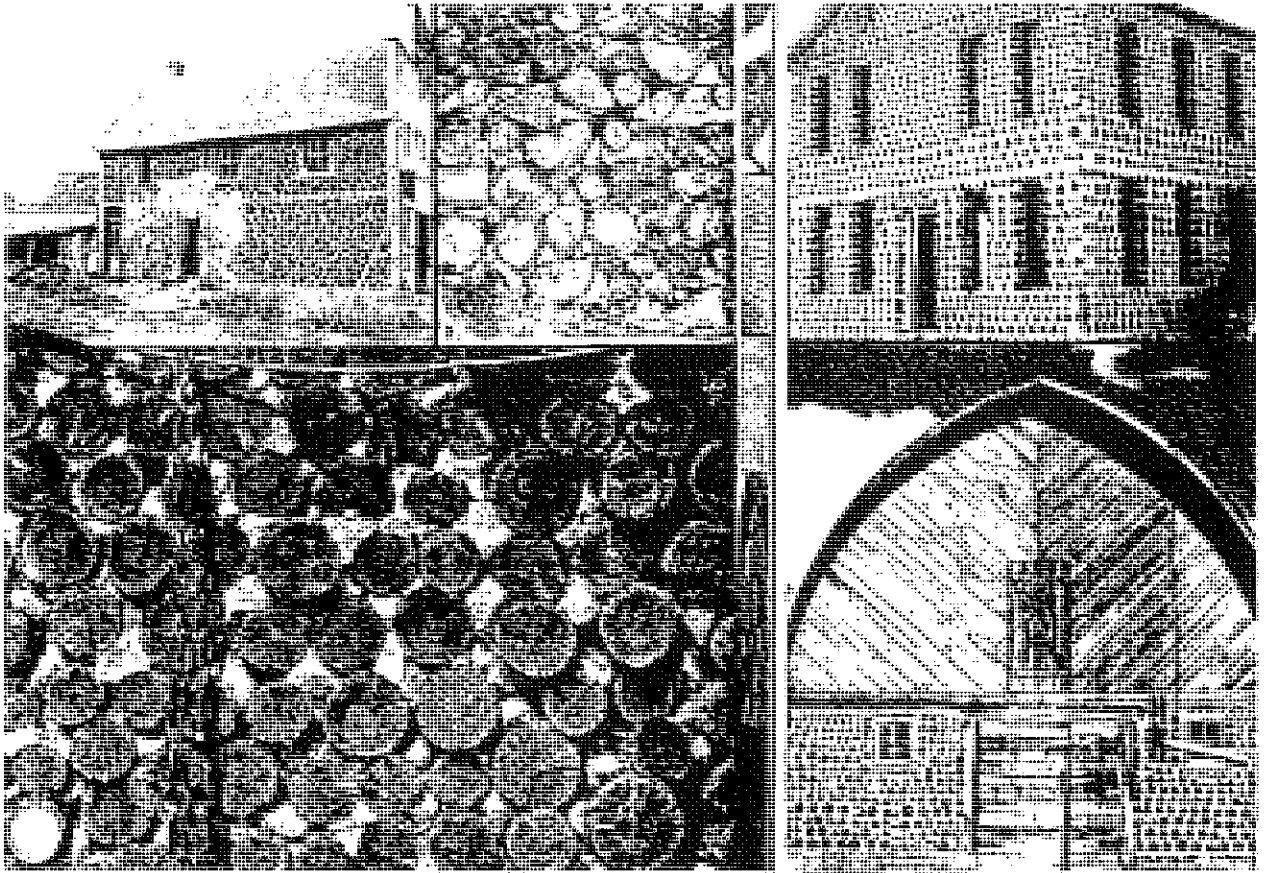

A CENTURY (OR MORE) OF STACKWOOD HOMES



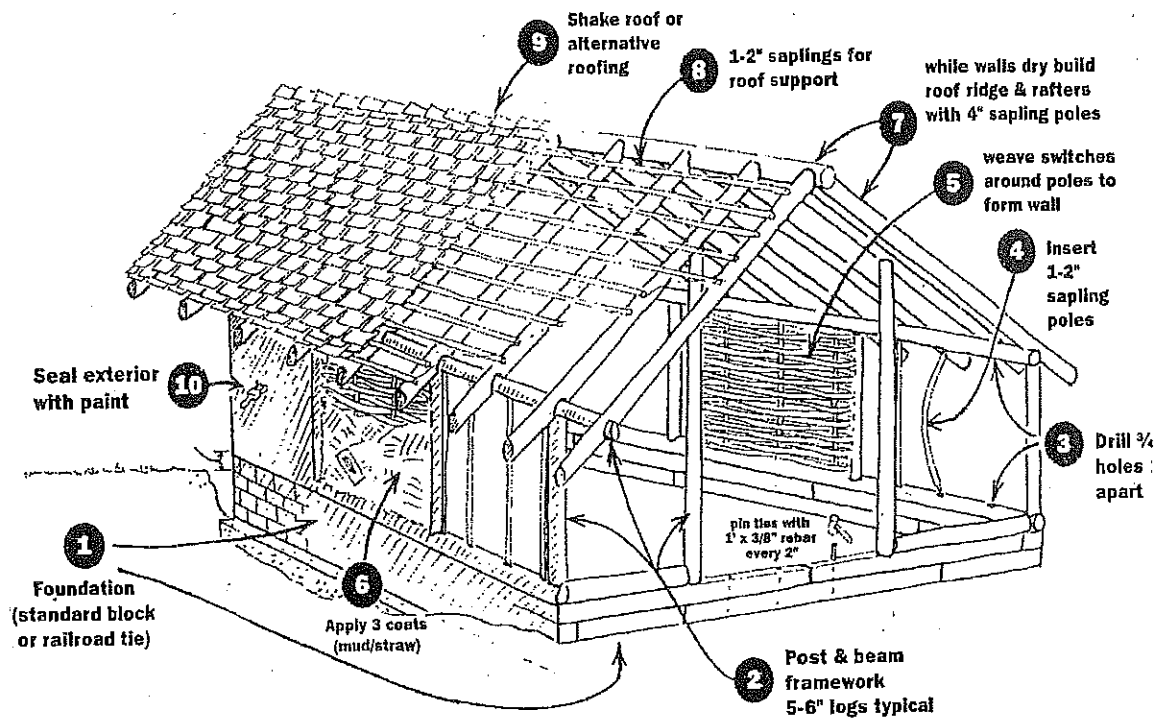

Use "wattle & daub" methods
for low-cost construction

BUILD WITH OLD TIRES

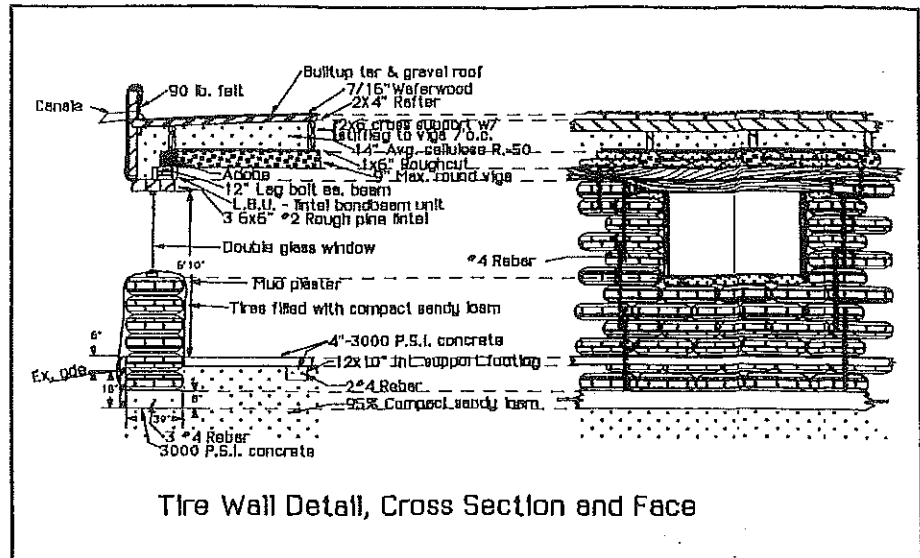

These illustrations come from *The Tire House Book* by Ed Paschich and Paula Hendricks. This book is an excellent, simplified overview of building with tires. It includes information on the time-saving technique of cutting out the top rim of each tire for easier compacting. *The Tire House Book*, Sunstone Press, Box 2321, Santa Fe, NM 87504-2321 © 1995, 505-988-4418

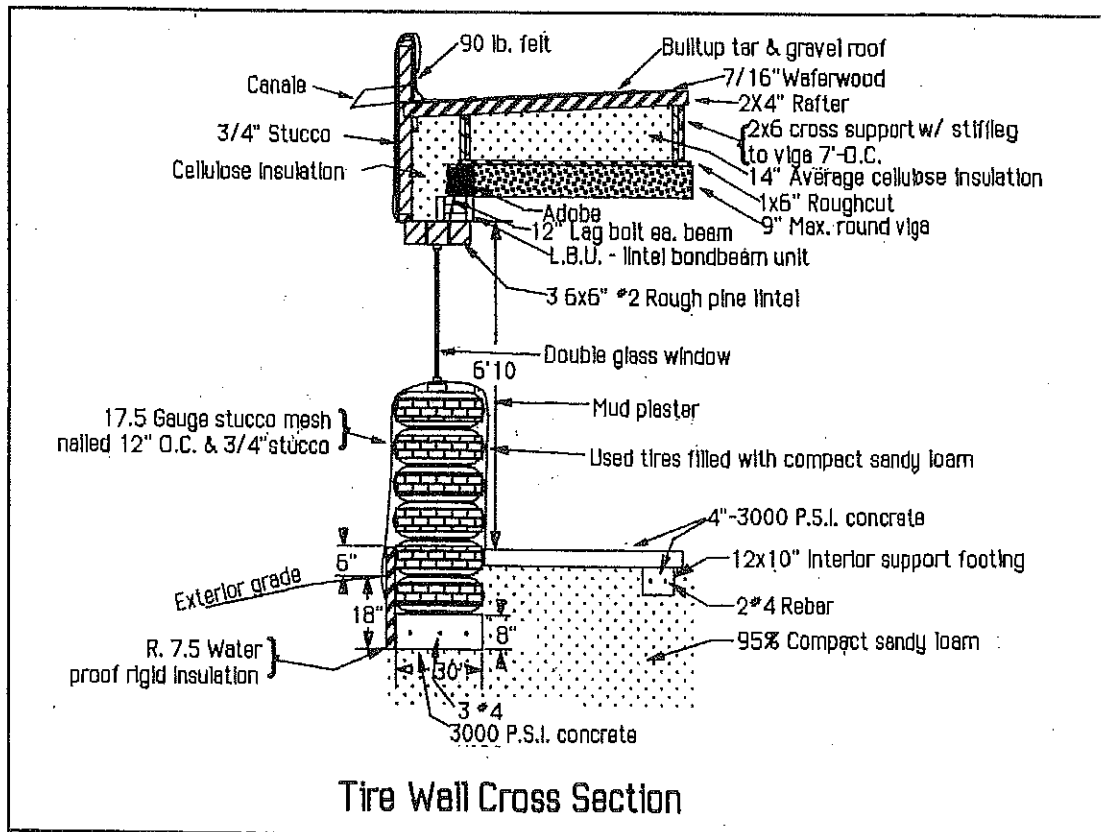

BUILDING THE STRAW BALES

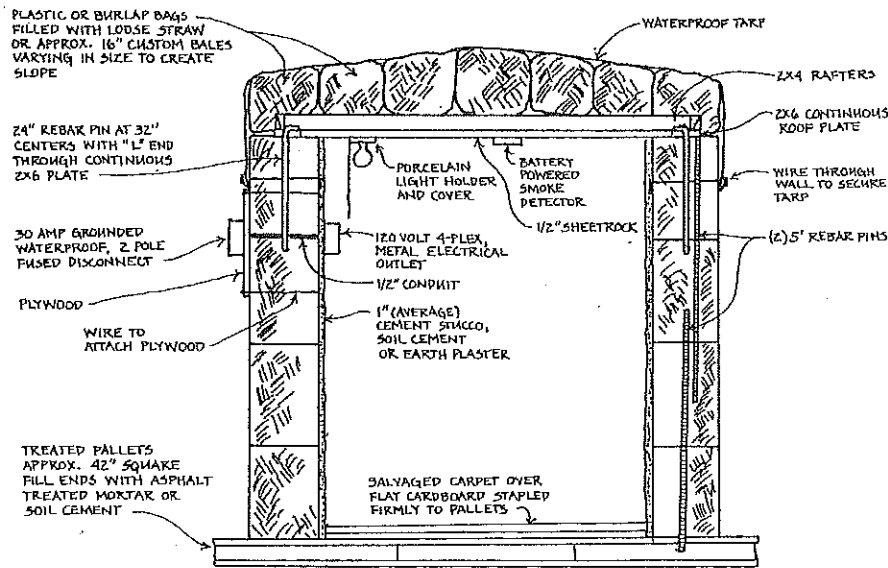

EMERGENCY SHELTER

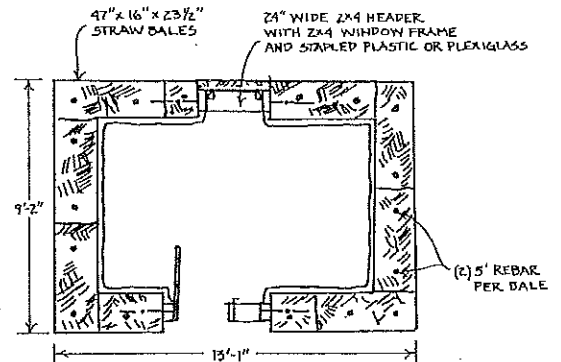
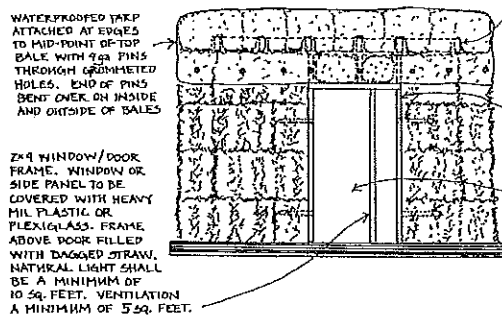

A cooperative project of the Development Center for Appropriate Technology and Out on Bale, with help from Tucson architect Bill Ford, has created a design for a temporary emergency shelter for victims of homelessness or disasters. The city of Tucson will issue permits to construct this straw-bale shelter, which can be inexpensively built, especially when using salvaged and donated materials. For further information, contact David Eisenberg of the Development Center for Appropriate Technology.

This illustration is from an excellent book, *The Straw Bale House*, from Chelsea Green Publishing, © 1994, p. 236.

Earthbag Building

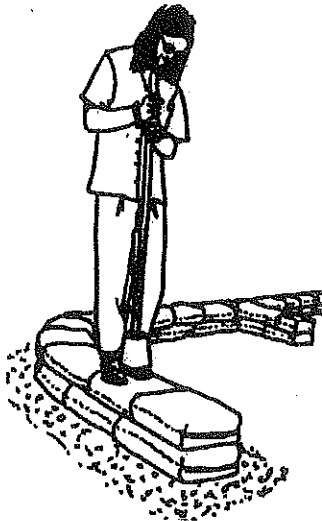

Poly bags, often used for feed, are filled with earth and tamped.

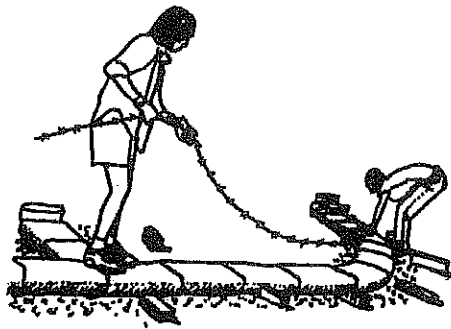

Barbed wire prevents bags from slipping.

These illustrations come from *Earthbag Building* by Kaki Hunter and Donald Kiffmeyer. This book provides clear, step-by-step instructions.

New Society Publishers
P. O. Box 189 Gabriola Island
BC VOR 1X0, Canada
copyright 2004

Another excellent resource is found on the Internet:
calearth.org/emergshelter.htm

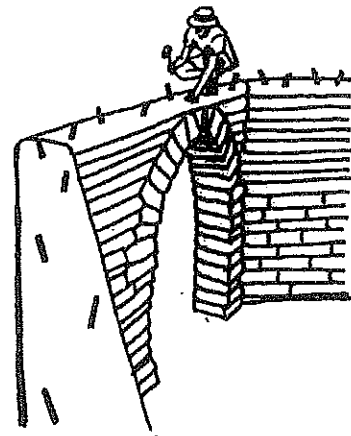

A bond beam ties walls together and provides a point of attachment for the roof.

RECOMMENDED READING

The Passive Solar Energy Book, Edward Mazria. Rodale Press, 1979. This is a must for anyone designing a passive solar structure. It is a compilation of hundreds of basic passive solar design ideas, with photographs.

Earthships I, II, III, Michael Reynolds. Solar Survival Press, Taos, NM, 1990. Another must. Michael lived out in the desert of New Mexico and put in 25 years of practical research. His work has provided a cornerstone for sustainable living design.

Solar Spaces, Darryl J. Strickier. Van Nostrand Reinhold Co., Inc., 1983. This book gives good examples of working solar greenhouse-type structures. Lots of good ideas for retrofitting an existing conventional house.

The Owner-Built Home, Ken Kern. Charles Scribner's Sons, 1975. This is a must for any serious builder. Kern has interesting layout ideas and simplified charts that will help any builder create a safe, sturdy dwelling.

The Have-More Plan, Ed and Carolyn Robinson. Great book about the rationale of homesteading. Fascinating because it was written in the '40's.

Solar Houses for a Cold Climate, Dean Carriere and Fraser Day. Charles Scribner's Sons, 1980. Good photos of solar installations.

Introduction to Permaculture, Bill Mollison and Reny Mia Slay. Tagari Publications, P.O. Box 1, Tyalgum NSW2484 Australia, 1991. Thought-provoking presentation on how all natural systems are intertwined. Good practical ideas on design and building. Reader must take into consideration that the authors are socialists, leaning toward pantheism.

The Passive Solar House, James Kachadorian. Chelsea Green Publishing. Box 428, White River Junction, Vermont 05001.

1997. Good primer for passive solar basics. Of particular interest is the author's Solar Slab concept for heat storage.

The New Ecological Home, Daniel D. Chiras, 2004, Chelsea Green Publishing Co., White River Junction, Vermont.

From Eco-Cities to Living Machines, by Nancy Jack Todd and John Todd, 1994. Lots of interesting ideas using biology, primarily composting and solar power, to solve living problems. Authors are committed socialists/communists.

MAGAZINES

For excellent examples of unique buildings, There are three periodicals that I read cover-to-cover. They present practical, often inexpensive solutions for the homesteader. For the most part, all three publications are written by people living the homestead life.

"Countryside" P.O. Box 6017, Duluth, MN 55806-6017 .1-800-551-5691, 8-4 Central time

"Back Home" P.O. Box 70, Hendersonville, NC 28793 1-800-992-2546

"Backwoods Home" P.O. Box 712, Gold Beach, OR 97444 1-800-835-2418

The Solar Ark...

**On-site water collection and
water conservation...**

**(water catchment and gray
water systems)**

STEPS ON THE PATHWAY TO ABUNDANCE

WATER

Matthew 5:45c ... He [God] sends rain on the righteous and the unrighteous.

Zechariah 10:1 Ask the Lord for rain in the springtime; it is the Lord who makes the storm clouds. He gives showers of rain to men, and plants of the field to everyone.

Leviticus 26:3-4 ³If you follow My decrees and are careful to obey My commands, ⁴I [God] will send you rain in its season, and the ground will yield its crops and the trees of the field their fruit.

Isaiah 24:4-5 ⁴The earth dries up and withers, the world languishes and withers, the exalted of the earth languish. ⁵The earth is defiled by its people; they have disobeyed the laws, violated the statutes and broken the everlasting covenant.

Improve and increase water resources by utilizing all rainwater that falls on your property.

Psalms 65:9 You [God] care for the land and water it; You enrich it abundantly. The streams of God are filled with water to provide the people with rain, for so You have ordained it.

Isaiah 41:17-18 ¹⁷[God speaking] The poor and needy search for water, but there is none; their tongues are parched with thirst. But I, the God of Israel, will not forsake them. ¹⁸I will make rivers flow in barren heights, and springs within the valleys. I will turn the desert into pools of water, and the parched ground into springs.

- Reduce erosion and increase rainwater infiltration.
Slow wind and water flow with vegetation, mulch, contouring, dams, swales, etc.
- Use roof catchment and cisterns or ponds to prepare for drought.

Proverbs 5:15 *Drink water from your own cistern....*

- Create a wooded area to increase rain through evapotranspiration. A large tree can put 300 gallons of water into the air daily.

Isaiah 41:17-20 (Notice how God speaks of increasing water and planting trees in the same chapter.) *[God speaking] The poor and needy search for water, but there is none; their tongues are parched with thirst. But I the Lord, will answer them; I the God of Israel, will not forsake them. I will make rivers flow in barren heights, and springs within the valleys. I will turn the desert into pools of water, and the parched ground into springs. I will put in the desert the cedar and the acacia, the myrtle and the olive. I will set pines in the wasteland, the fir and the cypress together, so that the people may see and know, may consider and understand, that the hand of the Lord has done this, that the Holy One of Israel has created it.*

- Avoid polluting any water source.

Ezekiel 34:18-19 *...Is it not enough for you to drink clear water? Must you muddy the rest with your feet? Must my flock feed on what you have trampled and drink what you have muddied with your feet?*

- Manage solid waste with composting.
- Send blackwater to septic systems.
- Reuse graywater for vegetation.
- Use irrigation methods that conserve water: drip systems, measured watering, sub-irrigation planters, etc.

Water System Diagram

(Dody residence)

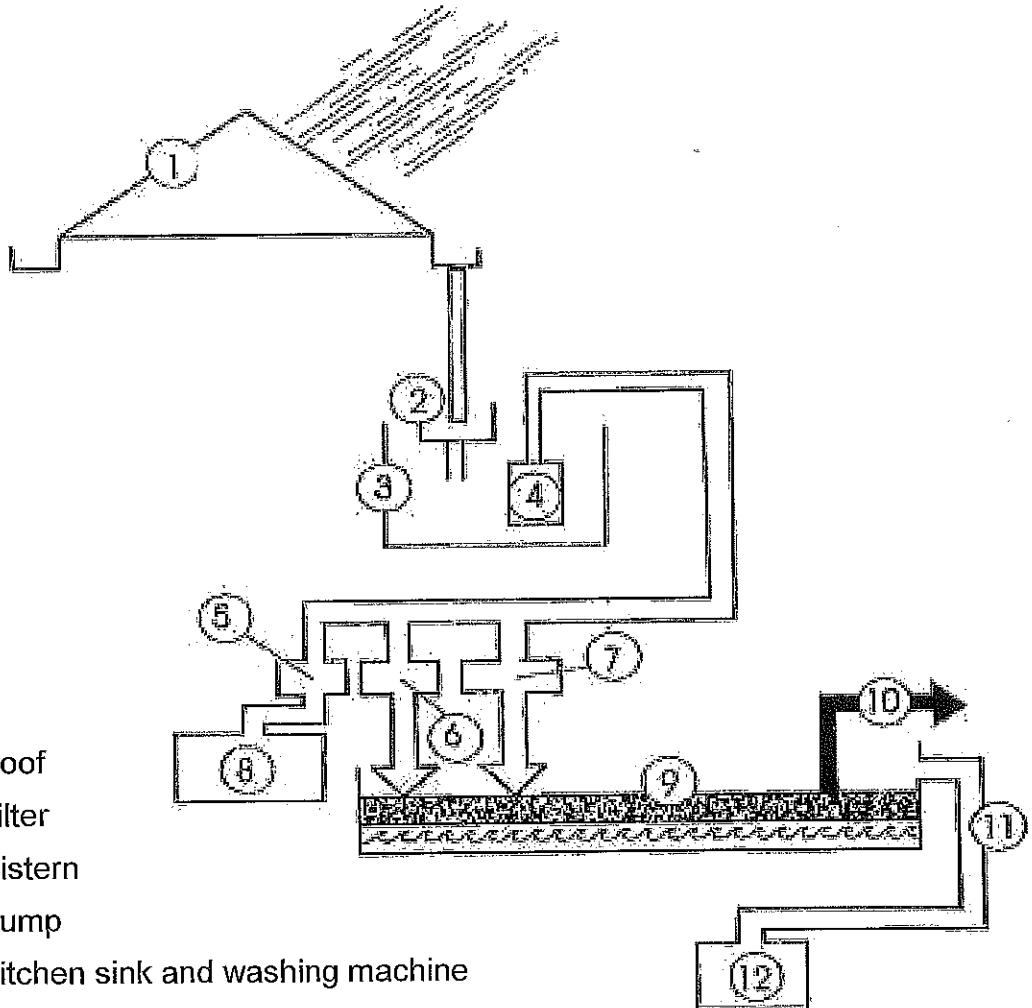

1. Roof
2. Filter
3. Cistern
4. Pump
5. Kitchen sink and washing machine
6. Bathroom sinks
7. Tub or shower
8. Kitchen drywell
9. Planter
10. Gray water for plants
11. Planter overflow
12. Planter drywell

SYNERGY

If you need less water, you
need to store less water.

If you need to store less water,
your holding tank can be much
smaller, simpler
and less expensive.

WATER SAVING IDEAS...

- ... Use handiwipes for hand cleaning and work surface cleaning. (You can make your own handiwipes.)
- ... Use the SIP method (Subterranean Irrigation Planters) for gardening.
- ... Use waterless hand sanitizer.
- ... Measure water for gardening
- ... Take "Marine" showers.
- ... Build a graywater system.
- ... Use polymers in the garden.
- ... Use mulch in the garden.
- ... Use containers for gardening.
- ... Use drip systems for irrigation.
- ... Use a tippy-tap.
- ... Use paper plates.



Water Conservation

The Secret to Successful Storage

By Doug Pushard

The most economical approach to water storage is water conservation. Being mindful of our most precious resource is neither difficult nor expensive, and simple lifestyle changes can have a major impact on how much water we actually consume.

1. The Bathroom

According to the U.S. Environmental Protection Agency, the bathroom typically uses almost 75 percent of the water used inside a house. If you can focus only on one room inside the house, focus on the bathroom.

- Toilets are the major consumer of fresh, clean drinking water in a typical house. Go low-flow at 1.6 gallons per flush, less than half of older toilets.
- Go with a dual-flush or composting toilet to save even more water. The new composting toilets are quick, odorless, and provide fertilizer for your yard.
- Check your faucets and toilets for

leaks at least annually. One drop per second can waste up to 2,700 gallons of pure drinking water a year.

- On average, a regular faucet uses about 4 gallons a minute. New low-flow models use half the water without noticeably affecting the pressure.
- Older showerheads (pre-1992) supplied water at up to 5.5 gallons per minute (gpm), while newer high-efficiency ones use no more than 2.5 gpm. By replacing your showerhead you could save 20 to 25 gallons per shower. Keep your showers to less than 5 minutes.
- Turn the water off while brushing your teeth.

2. The Laundry Room

- New Energy Star clothes washing machines can save up to 20 gallons or more per wash over older models.
- When doing laundry, always match the water level to the size of the load. Only wash full loads of laundry when possible.

3. The Kitchen

- Replace your current kitchen faucet with a new low-flow model.
- Wash your produce in a pan and reuse the water in your garden.
- Avoid defrosting frozen foods under running water.
- Use your dishwasher a second time, by putting it in the garden instead of down the drain.
- Sink disposals use a lot of water. Start a compost bin and avoid using the kitchen disposal altogether.
- When buying a new dishwasher, look for an Energy Star model.

4. The Outdoors

Summer will be here sooner than you think. Outdoor watering in the hot season can use more than 40 percent of the water consumed, depending on how arid it is where you live. It is the biggest consumer of summertime water.

- Install a drip irrigation system. It delivers water only to the plants and not to bare soil. Heads can be correctly sized for each plant.
- Water only during the morning hours, to reduce evaporation. Invest in a multifunction zoned irrigation timer. These timers allow you to set different watering times for your trees, shrubs, flower beds, vegetables and other plants. Water only the amount you need to water for each type of plant. Overwatering your plants is bad for them and bad for the pocketbook.
- If you have a sprinkler or drip irrigation system, install a rain gauge. No need to water if it is already raining!
- Rip up that lawn and go with native plants that are less water-intensive. This does not mean a rock garden; in almost all areas of the country there are colorful native plants and grasses that use much less water and add color spring through the fall.
- Never just let the hose run. Install good quality, nonleaking nozzles on all hoses.
- Lay two to four inches of mulch around plants to retain moisture.
- Install porous materials for walkways and driveways to keep the water in your yard.
- Use a broom, not water, to clean outside areas.

A WATER CATCHMENT SYSTEM

Unless you have a good spring or a year-round creek flowing across your property, catching rainwater is often the simplest and least expensive way to secure the water that you need.

My friend, Glen Eitemiller, is dedicating his life to the poor, helping them have clean water. Here are his words: "I am increasingly a believer in rain water harvesting! It is such a no brainer! It's free, easy to collect, and in most cases it's the best water available."

Advantages

- ⊗ Rain is often the cleanest water source available if harvested before touching the ground.
- ⊗ Rain is naturally distilled through evaporation.
- ⊗ Rain is soft due to lack of calcium carbonate or magnesium in solution, and is excellent for cooking and washing.
- ⊗ Rain is natural fertilizer. It contains sulfur, microorganisms and mineral nutrients collected from dust in the air.
- ⊗ Rain has the lowest salt content of natural fresh water sources, making it excellent for plants.
- ⊗ Rain is a free gift from God.

Source

Rainwater Harvesting for Drylands and Beyond, vol. 1, by Brad Lancaster, 2006, p. 6&7.

Disadvantages

- ⊗ Your water supply is affected by drought.
- ⊗ You must ingest minerals to replace those typically found in well water.

Synergy

- ⊗ A deep well requires a large electric pump, which requires a large solar array with lots of batteries.
- ⊗ A catchwater system requires a small pump (or no pump at all), which works well with a very small solar array and a few batteries (or no batteries at all).

Roofing Materials for Water Catchment Systems

1. Unpainted galvanized metal
2. Painted metal roofing with lead-free baked enamel
3. EPDM (rubber) roofing
4. Slate, tile, or concrete
5. Untreated wood

Note: If your roof is covered by tree limbs, leaves and bird droppings can contaminate your water.

Safety Alert: Make sure no lead is used in paint or solder that is used to make gutters.

Safety Alert: Make sure any containers used for rainwater were not used previously for toxic materials.

Using Sheathing as Part of Your Catchment System

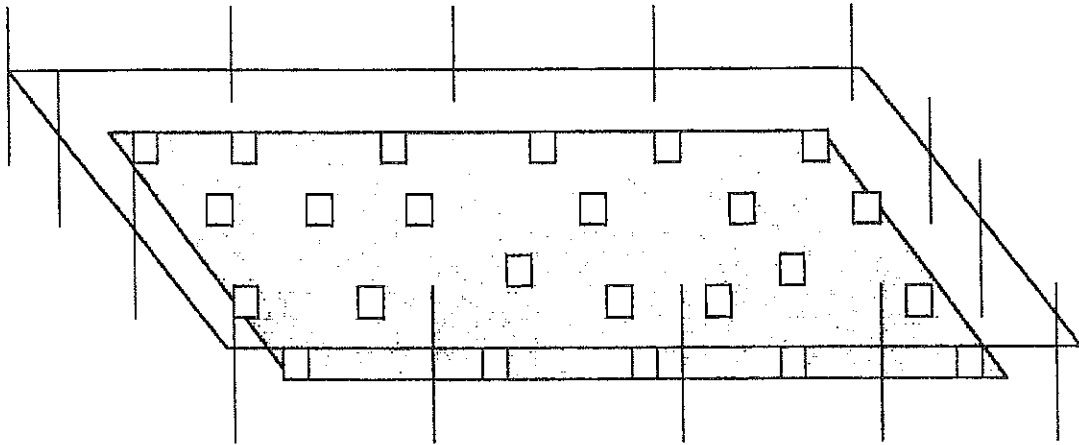

1. Use black 6 mil. or heavier polyethylene sheathing.
 2. Put the catchment area away from trees.
 3. Hold the sheathing in place with stones, bricks, concrete blocks, etc. (Don't use old tires; they make breeding places for mosquitoes).
 4. Fence off the catchment area.
- (Not shown: A tank to store the water that falls on the sheathing).

Building a Holding Tank for Water Catchment

Note: Water weighs about 8 pounds per gallon. Your floor must be able to support the weight of your holding tank.

1. Build a box frame with 2 x 4's on 12 inch centers. The box shall be 24" wide and 36" high and as long as is needed and/or practical. The box shall have a removable lid.

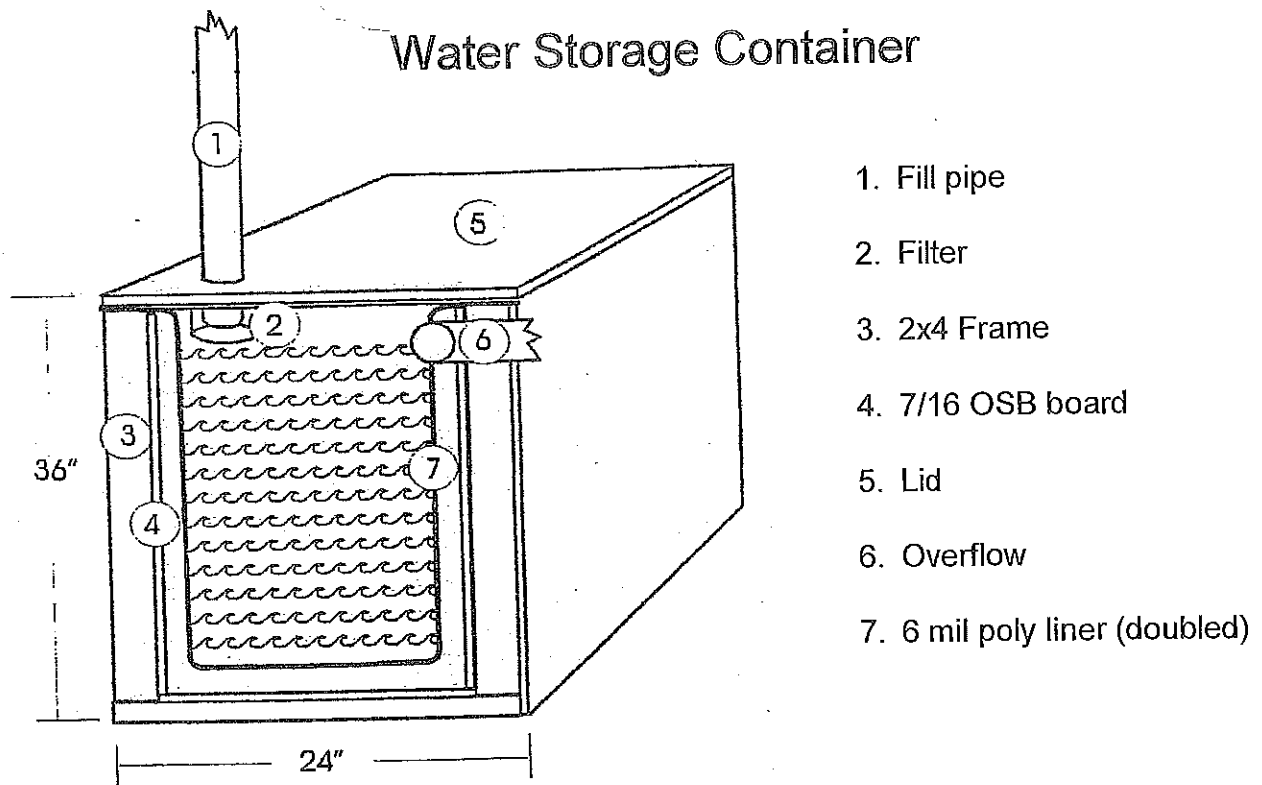

2. Cover the 2x4 frame with 1/2 inch to 3/4 inch O.S.B. board or plywood.
3. Glue and screw the OSB or plywood to the 2 x 4 frame,
4. Check the box for any sharp objects or rough areas that could puncture or tear the poly liner.
5. Line the box with one continuous piece of black 6 mil. polyethylene sheathing. Black is less affected by ultraviolet light and lasts longer than clear. Use two thicknesses for safety. This sheathing is often called Visqueen and is sold in hardware stores and garden shops.

**Consider FDA approved, food quality sheathing.

Note: 6 mil. polyethylene is usually available in 10 foot widths.
A 10 foot section will fit nicely into the 2' x 3' box you have built.

Note: During manufacture, 6 mil. sheathing can develop small holes. Lay out the sheathing for the holding tank and check it carefully before lining the holding tank.

6. Fill the holding tank very slowly the first time and check it for leaks.
7. Build an overflow for the holding tank. If you have a 3-inch pipe filling the tank, you need two 3-inch pipes for the overflow.
 - A. Place the pipe through the wall of the tank at the highest point possible.
 - B. Stretch the sheathing around the overflow pipe.
 - C. Use a stainless steel clamp to secure the sheathing.
 - D. Cut out the sheathing that is stretched over the overflow pipe.

Drain

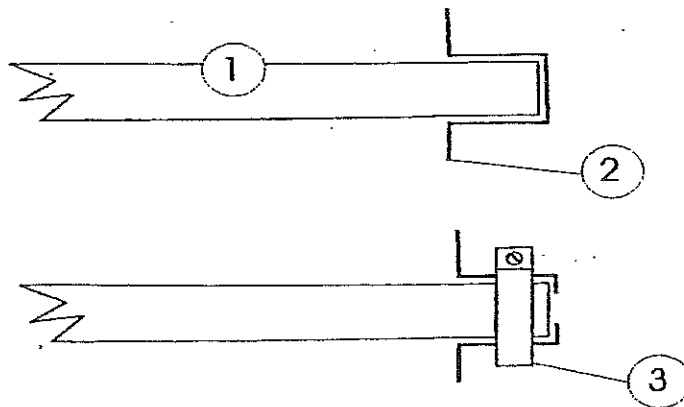

1. Pipe.

2. Poly liner.

3. Stainless steel clamp.

Note: The top of the holding tank is the standard height of a kitchen cabinet. It makes an excellent work surface or plant shelf.

Note: Having the holding tank in your living space is a great way to moderate air temperatures. Make sure that air can move easily around the box. Do not set it directly against a wall; leave a gap of one or two inches to encourage air movement.

Maintaining the Holding Tank

1. The water coming directly from your roof should be clean enough for bathing and washing dishes. It must be purified for drinking.
2. Over time, sediment will develop on the bottom of the holding tank. Unless it is very deep, this sediment layer can be ignored. If too much sediment collects in the tank, it can be cleaned out carefully to avoid tearing the liner. (Jack's Note: After eight years in a very dusty area, less than an inch of sediment has collected.)
3. Occasionally, the water in the holding tank will develop a musty odor. This occurs because of the bacteria in the tank. A small amount of chlorine bleach will eliminate the problem. An inexpensive swimming pool test kit will allow you to test for bacteria.
4. Always keep the holding tank covered and not exposed to sunlight. Sunlight will encourage algae growth.

More Information About Holding Tanks

As more people in the United States are harvesting rain water, there are many websites that offer education on many different types of holding tanks. Use keywords "rainwater harvesting" to find information.

ANOTHER TYPE OF HOLDING TANK – THE BURIED HOLDING TANK

Advantage

Since it is buried, it does not take up space in a building.

Disadvantages

Since it is buried, it is difficult to maintain.

Since it is not in the living space, it will not help moderate living space temperatures.

Note: In non-freezing climates or where digging is too difficult, the tank may be placed on the surface and then covered with soil. It must be covered to prevent solar disintegration of the pond liner.

Buried Holding Tank

1. Dig a pit a bit wider than the diameter of the tires to be used. Line the pit with old carpet, etc. to protect the pond liner. Place the pond liner in the pit. Place tires in the pit. Tires will be wrapped like a Tootsie Roll.

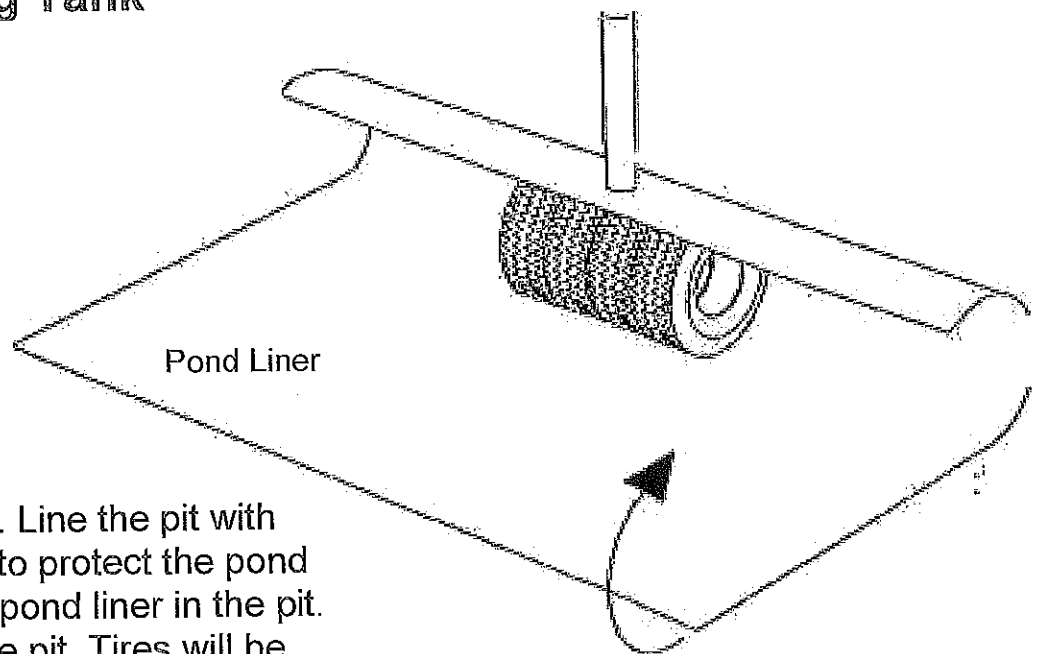

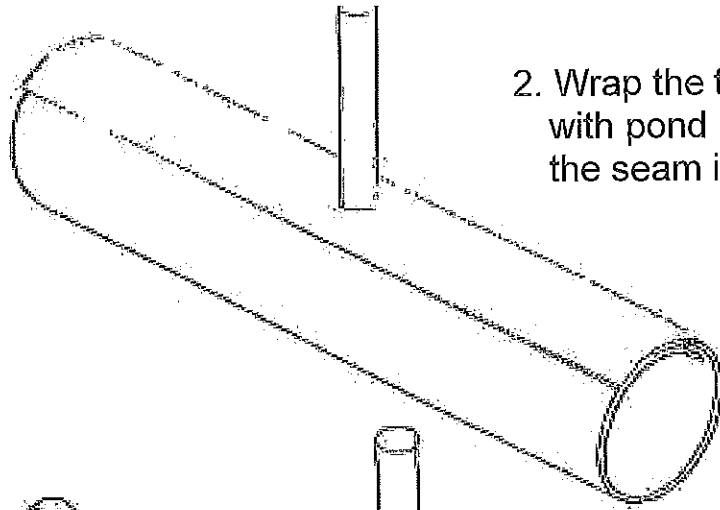

2. Wrap the tires completely with pond liner, Make sure the seam is at the top

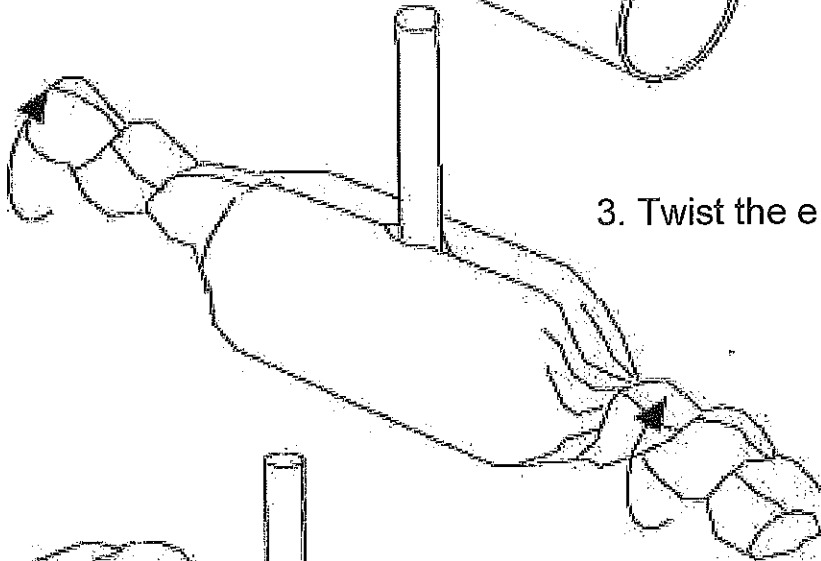

3. Twist the ends of the pond liner

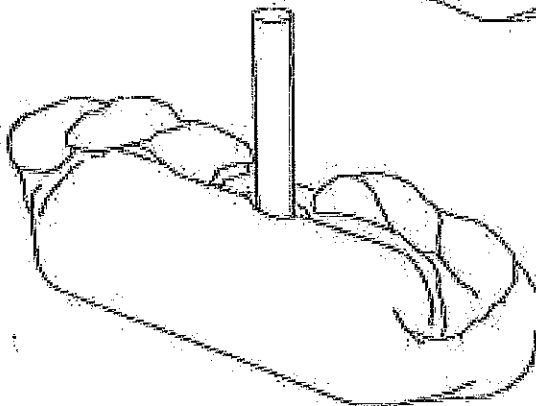

4. Pull the twisted ends up and over the top of the tires. Carefully install vent/fill/access/overflow.

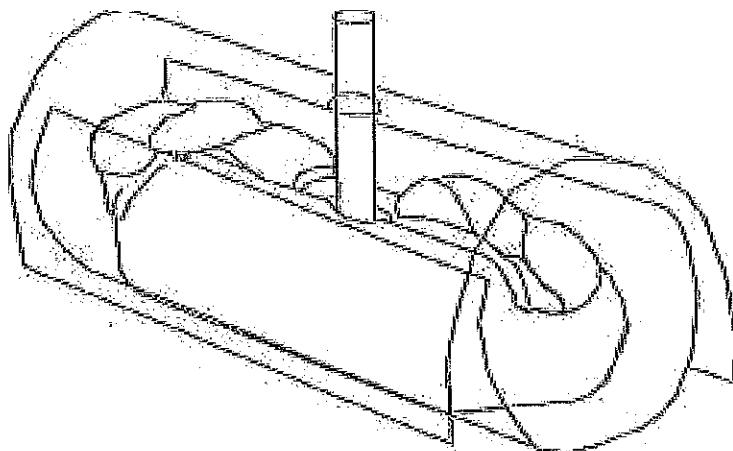

5. Cover the top of the wrapped tires with carpet to protect the liner.

6. Fill the tank with water and test for leaks.

7. Carefully bury the tank.

8. Keep cars and trucks from driving over the tank.

CONSTRUCTING THE BURIED HOLDING TANK

Materials Needed:

- Old tires
- Old cardboard, plastic sheathing, tarps, carpet, etc.
- PVC pipe and fittings
- Pond liner

How to Construct a Buried Holding Tank

1. Dig a trench just a bit wider than the diameter of the tires being used.

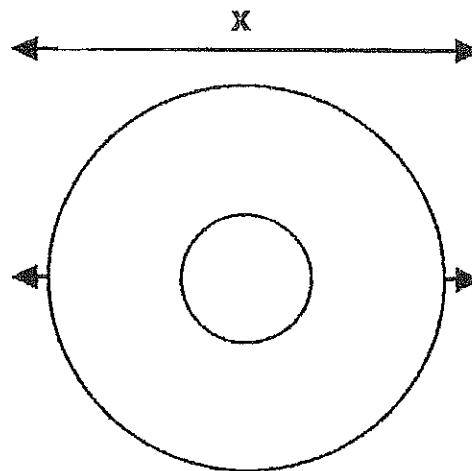

Locate the tank a safe distance from the living structure. Think ahead. What will happen if it leaks?

Note: In cold climates, the tank may need to be six feet deep to prevent freezing.

Note: In areas that are difficult to dig, the tank can set on the surface. It must be completely covered with soil to protect the poly liner from ultraviolet rays.

2. Once the trench is dug, it shall be lined with a pond liner. Be careful not to tear or puncture the liner.
3. The tires shall be placed into the lined trench carefully, so as not to puncture the pond liner.
4. The tires placed on each end of the trench shall have sheet metal placed over the wheel hole. This will keep dirt from filling in the tires. Another method uses tires placed horizontally at each end of the trench. The horizontal tires must be filled with compacted soil.
5. The pond liner shall be carefully wrapped about the tires to create a tank that will hold water. (see diagrams)
6. The vent/fill/access/overflow pipe shall be put in place from the top of the tires through a carefully made slit.
7. Fill the tank and test for leaks before burying.
8. The pond liner shall be covered from the top with old cardboard or sheathing or carpet or an old tarp, etc. This will protect the sheathing when the tires are carefully buried.
9. Bury the tank. Compact the soil gently. Leave a mound over the tank - it will settle over time.
10. Place markers or a fence around your buried tank so that it will not be driven over. You can walk over it with no problems.

Note: One of the most inert objects on the planet is an old tire. Tests have not yet been done to see how the water would be tainted in a buried holding tank constructed with old tires. The water will certainly be acceptable for watering plants. What type of purification is necessary to make the water potable is a question that needs to be answered.

Note: It may make financial sense to build two separate holding tanks, a smaller tank for drinking water only and a larger tank for other purposes. The larger tank would not need to be built of expensive materials that meet potable water standards.

Extracting Water from the Buried Holding Tank

A hand pump, a submersible electric pump powered by a solar panel, a gas-powered trash pump, or a dirty water pump will remove water from the buried holding tank. Tank access is through the vent/fill/access/overflow. Choose your method of extraction and make sure it will work before you bury the holding tank.

Constructing the Vent / Fill / Access / Overflow

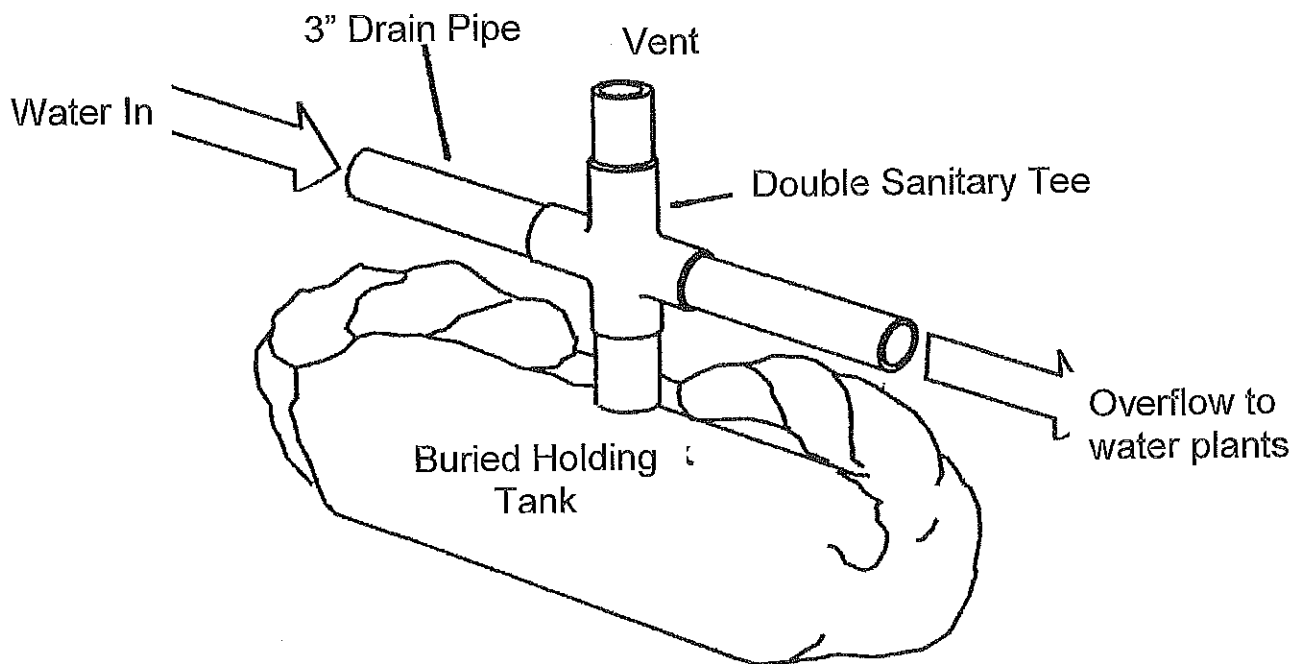

CALCULATING WATER NEEDS AND AVAILABILITY

One inch of rain on one square foot of catchment surface will yield .623 gallons.

Note: Allows for 1/3 of water being wasted due to leakage, roof washing, and evaporation. Based on recommendation of Harry L. Garver, *Safe Water for the Farm*, F.B. 1978, 1948.

Important Questions to Consider About Water Catchment

1. What is the average rainfall in your area?
2. Does the rain come in a very short period of time, or does it rain throughout the year?
3. What is the size of your catchment area?
4. How much water do you use daily?
5. How large a holding tank is needed?

Calculating the Size of the Holding Tank

One cubic foot of water is approximately 7.5 gallons.

To calculate the volume of a square or rectangular box:
multiply width x height x length = cubic feet.

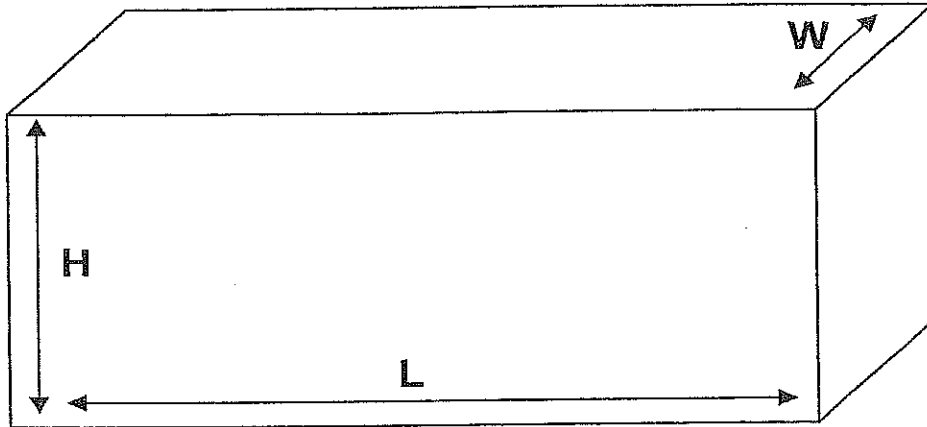

Cubic feet x 7.5 equals the number of gallons that can be contained in a square or rectangular box.

It is often necessary to measure the holding tank in inches. One cubic foot contains 1728 cubic inches.

A Practice Problem

You have a home that is 16' x 20'. You also have an area in a field beside your home that is covered with black 6 mil. sheathing. It is 20' x 50'. It rains 12 inches annually in your area, usually in just two consecutive months. The rest of the year is very dry.

Discover the following:

How many gallons of water will fall on your roof and sheathing in an average year?

How large a holding tank will you need?

PURIFYING YOUR WATER

If you use a catchment system and maintain it properly, your water should be clean enough for bathing, cooking, cleaning, and watering plants.

Drinking water must be purified.

Techniques for Water Purification

1. Chemicals - chlorine
2. Filtration
3. SODIS

(This list excludes many purification strategies that are too complicated and/or expensive. The techniques listed are simple, inexpensive and reliable.)

Basic Bleach Method

For emergency treating of water of unknown quality, use any household bleach containing sodium hypochlorite (5.25% solution) *without* soap additives or phosphates. By using common household bleach as a chemical treatment method, large amounts of safe drinking water can be provided quite inexpensively. **Clorox has a 12-month shelf life.**

Follow these simple instructions:

- Add bleach to water in container
- Thoroughly mix bleach in water by stirring briskly
- Let mixture stand for at least 30 minutes

Caution:
Be sure sodium hypochlorite is the only active ingredient in bleach when used for water treatment.

Note: Conditions requiring longer exposure to the chlorine are cold water and heavy turbidity. The colder the water and the airier the water, the longer the time required for the chlorine to kill contaminants. Chemicals do not purify water; they merely render the water potable by neutralizing some of the toxic animal and plant life in the water.

Basic Bleach Water Treatment Method

Water Quantity	Water Condition	5.25% Sodium Hypochlorite
1 quart	clear	2 drops
	cloudy	4 drops
½ gallon	clear	4 drops
	cloudy	8 drops
1 gallon	clear	8 drops
	cloudy	16 drops
5 gallons	clear	½ teaspoon
	cloudy	1 teaspoon
120 gallons	clear	2 ounces
	cloudy	4 ounces

Mixture should still have a distinct chlorine taste or smell after waiting period. If chlorine smell is not detected, add same dose of the solution to the water and let mixture stand for an additional 15-20 minutes.

From *Making the Best of Basics* by James Talmage Stevens, Gold Leaf Press, ©1997.

CERAMIC FILTERS

The Katadyn Drip Filter

With no moving parts to break down, superior filtration, and a phenomenal filter life, there is simply no safer choice for potentially pathogen-contaminated water. There are no better filters than Katadyn for removing bacteria, parasites, and cysts. Three 0.2-micron ceramic filters process one gallon per hour. Clean filters by brushing the surface. Ideal for remote homes, RV, camp site, and home emergency use. Food-grade plastic canisters stack to 11" Dia.x 25" H. Weighs 10 lb. One-year manufacturer's warranty, Switzerland.

42-842 Katadyn Drip Filter \$289

42-843 Replacement Filter (needs 3) \$75 ea

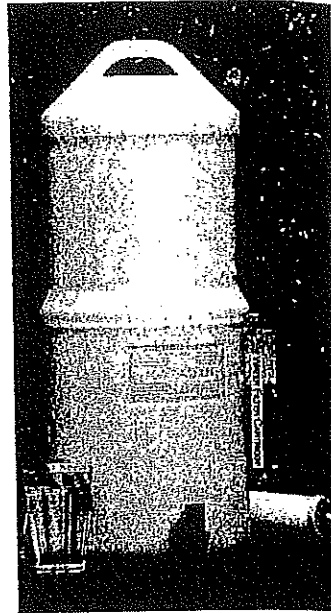

Ceramic filters are simple to use and they require no electricity. Always have extra ceramic candles (the filter part) on hand. Ceramic filters are pricey, but will work for years if properly maintained. If the water to be filtered is muddy, it should be sent through a sand filter before it is sent through the ceramic filter. Muddy water will clog the ceramic candles very quickly. The illustration is from Real Goods. Other brand names you may want to consider are Berkey and Doulghton.

In the past, ceramic filters did little to filter chemical pollutants. A new ceramic filter from Berkey does remove some chemicals. This will be particularly important in areas that are or once were heavy industry areas. Here is information from the Berkey Company about the Black Berkey filter. Cost is \$50 each (2009).

The revolutionary Black Berkey, self-sterilizing and cleanable purification elements purify water by removing pathogenic bacteria, cysts and parasites entirely and by extracting harmful chemical such as herbicides, pesticides, VOCs, organic solvents, radon 222 and trihalomethanes. They also reduce nitrates, nitrites and unhealthy metals such as lead and mercury without removing the healthful and nutritional minerals that your body needs. Black Berkey purification elements are so powerful that they are able to remove microscopic food coloring particles from water without removing the beneficial minerals your body needs. Virtually no other filtration system can duplicate this performance.

Moreover, Bekey systems are ideal for the self-sufficient, because they have the capability of purifying both treated water and untreated raw water from such sources as remote lakes, streams, stagnant ponds and water supplies in foreign countries, where regulations may be substandard at best. Perfect for everyday use and a must in hostile or emergency environments where electricity, water pressure or treated water may not be available. What's more, the Black Berkey elements are cleanable and can be used over and over again. Black Berkey elements will also fit most other major brand gravity filtration systems. www.berkeywater.com

THE SAWYER SP1803 PointOne Filter

Note from Jack: This filter is an excellent choice for those who want the safety and ease of operation of ceramic or catadyne filters without the high costs. The Sawyer filter starts at \$60 for the basic filter. For \$120 you can get a unit that will even filter out viruses.

This Filter Removes:

Bacteria, Which Cause:

I.E.: Cholera, Botulism (*Clostridium botulinum*), Typhoid (*Salmonella typhi*), Amoebic Dysentery, E. Coli, Coliform Bacteria, Streptococcus, Salmonella

Protozoan (Cyst):

I.E.: Giardia, Cryptosporidium, Cyclospora

Using technology taken from kidney dialysis, Sawyer® water filters use Hollow Fiber Membranes. Our filters are comprised of tiny "U" shaped micro tubes that allow water to enter into their core through tiny micro pores. The PointOne Filter's™ pores are so small (0.1 micron absolute) that no bacteria, protozoa, or cysts like E.Coli, Cholera and Typhoid can get through. At 7 log (99.99999%) the filter attains the highest level of filtration available today and yet it has a very high flow rate due to the large amount of tubes. Each filter is certified for ABSOLUTE microns. That means there will be no pore size larger than 0.1 microns in the biological filter. Simply put, it is impossible for bacteria to pass through the 0.1 micron filter.

Assembly Kit Includes:

- 1 - Hole Cutter
- 1 - Water Filter, adapter & 3 Foot Hose
- 1 - Backwash Syringe
- 1 - Filter Hanger
- 1 - Filter Cap
- Detailed Instruction Sheet

Sawyer made it as simple as it gets. No more digging wells if there is a water source, no constructing sand filters and no more purification chemicals. Families are able to construct and adapt their filter in literally minutes to locally found containers. The kit includes everything you need to attach the filter to any plastic bucket or container. (Bucket not included)

- 1 Obtain a clean bucket or plastic container
- 2 Use the hole cutter to drill a hole 1.5 inches from the bottom of the bucket (you can do this by hand).
- 3 Screw the connector, hose and filter onto the bucket.
- 4 Fill the bucket with water from any source, lower the filter head below the water line, and let gravity do the rest.

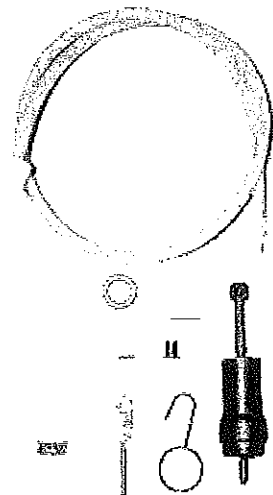

Fig. 1000

CAWST BioSand Filter

Construction: Concrete

Cost: A bag of cement and 3 feet of PVC pipe - \$10 -20.

Effectiveness: Removes 98% of contaminants

Capacity: 1 liter per minute

Producer: Center for Affordable Water and Sanitation Technology

Web address: www.CAWST.org

Advantages: Low costs. No power required. Low maintenance.

Note: You must have training and concrete forms to build this filter.
Contact EQUIP for more information.

EQUIP, Inc., P.O. Box 11267, Marion, NC 28752

www.equipinternational.com / 828-738-3891

Plans for another excellent sand filter are available at www.aquaclara.org
Go to the *Purifier Construction Manual* for step by step instructions.

I like this filter because it can be constructed using inexpensive materials that can be found almost anywhere.

Solar Disinfection - SODIS

Materials needed: Clear plastic pop bottles, 1 or 1½ liters
Polyethylene Terephthalate (PET) bottles are preferred.
PVC can have harmful additions.

Solar cooker (optional)

Sand Filter (optional)

Oven thermometer (optional)

WAPI – An excellent addition to the SODIS system is a Water Pasteurization Indicator (WAPI). The reusable, durable WAPI is a simple device containing a special soy wax that helps users determine when water has reached pasteurization temperatures. In 2005 the WAPI could be purchased for \$6 from *solarcookers.org*.

Procedure:

1. Fill bottle half way with clear water. Use a sand filter to pre-treat muddy water.
2. Shake vigorously.
3. Fill to the top.
4. Expose to direct sunlight for at least 6 hours (2 days in cloudy weather), or until the water reaches 55° C (135° F).

How it works: Sunlight helps kill micro-organisms as UV-A radiation is directly absorbed by organic material. Sunlight radiation also produces highly reactive forms of oxygen which kill micro-organisms. Heat kills some micro-organisms.

To improve efficiency:

1. Fill bottles completely.
2. Put black paint with no lead from top to bottom on half of the outer surface of the bottle. Lay the bottle horizontally with the blackened side downward.
3. Place bottles on a reflective surface such as aluminum foil.
4. Replace scratched bottles.

Sources: First presented by Professor Aftim Acra, UNICEF, 1984. Tested by the Swiss Federal Institute of Environmental Science and Technology (EAWAG) and the Department of Water and Sanitation in Developing Countries (SANDEC).

Recommended Reading

Cottage Water Systems, Max Burns. Cottage Life Books, 1993

The Home Water Supply, Stu Campbell. Garden Way Publications, 1983

Making the Best of Basics, James Talmage Stevens. Gold Leaf Press, 1997.

Handmade Hot Water Systems, Art Sussman and Richard Frazier.
Garcia River Press, P.O. Box 527, Point Arena, CA 95468, 1998

Mother Earth News, "The Secrets of Low Tech Plumbing," John Vivian.
June/July, 1995, p. 34.

"Rainwater Harvesting" Texas Water Development Board, P. O. Box
13231, 1700 N. Congress Avenue, Austin, TX 78711-3231. (512)
463-7847, Fax (512) 478-2053.

Rainwater Harvesting For Drylands and Beyond, vol. 1 and 2. By Brad
Lancaster, 2002. This is a must-read, ground-breaking work.

Build Your Own Solar Water Heater, Stu Campbell. Garden Way
Publishing, 1978.

Rain Catcher, Stephen Derynck, *Mother Earth News*, Feb./March 2004.

Harvest the Rain, *Environmental Building News*, *Mother Earth News*,
Aug./Sept. 2003.

Important articles on water purification from *Backwoods Home Magazine*

Emergency and Backwoods Water Treatment

Part 1 – *The Theory*, March/April 2010

Part 2 – *The Practice*, July/August 2010

Part 3 – *Taking It To the Field*, September/October 2010

A Solar Ark Conserves All Water Used...

A GRAY WATER SYSTEM

Words to Know:

Gray Water — Water that has been used that is not contaminated with urine, feces or harsh chemicals.

Black Water — Water that has been used that is contaminated with urine, feces, or harsh chemicals.

Gray Water System — A system that facilitates using gray water for trees and plants.

Drywell — A covered pit that allows gray or black water to drain into the soil where it is filtered and purified.

SYNERGY AND GRAY WATER

If you use water more than once you will need less water. If you need less water you will need a smaller holding tank. If you use less water you will need a smaller dry well, surface mound or septic system. Less water requires a smaller pump. A smaller pump requires a smaller and less expensive electrical system.

Guidelines for an Effective Gray Water System

(Much of the following information comes from an article by Claire Anderson in Mother Earth News, August/September 2004, pp. 100-106.)

1. Do not save gray water in a tank. It will become black water as bacteria multiplies.
2. Do not use kitchen sink water that is contaminated with food particles which attract insects and animals. This water should go to a black water disposal system.
3. Do not use water that has been used to wash diapers; it is contaminated with feces. It should go directly to a black water disposal system.
4. Do not over-water plants and trees. Make sure you have adequate space and drainage for the amount of gray water you produce.
5. Use fresh water about 50% of the time to help wash away salts that can build up and damage plants.
6. Acid-loving plants do not like gray water.
7. Do not let gray water stand in pools. Catchment basins must be large enough to absorb all the water sent to them.

How to size catchment basins

kitchen sink 5 to 15 gallons per person per day
bathroom sink 1 to 5 gallons per person per day
top-loading washer..... 30-50 gallons per load
front-loading washer 10 gallons per load
bathtub..... 25-40 gallons per bath
(from *Create an Oasis with Gray Water*)

8. Do not plant edible root crops in gray water.
9. Be careful not to splash gray water on edible plants.
10. Wash all edible plants with soap or iodine.
11. Do not use perforated pipe - it clogs.

GRAY WATER SYSTEM

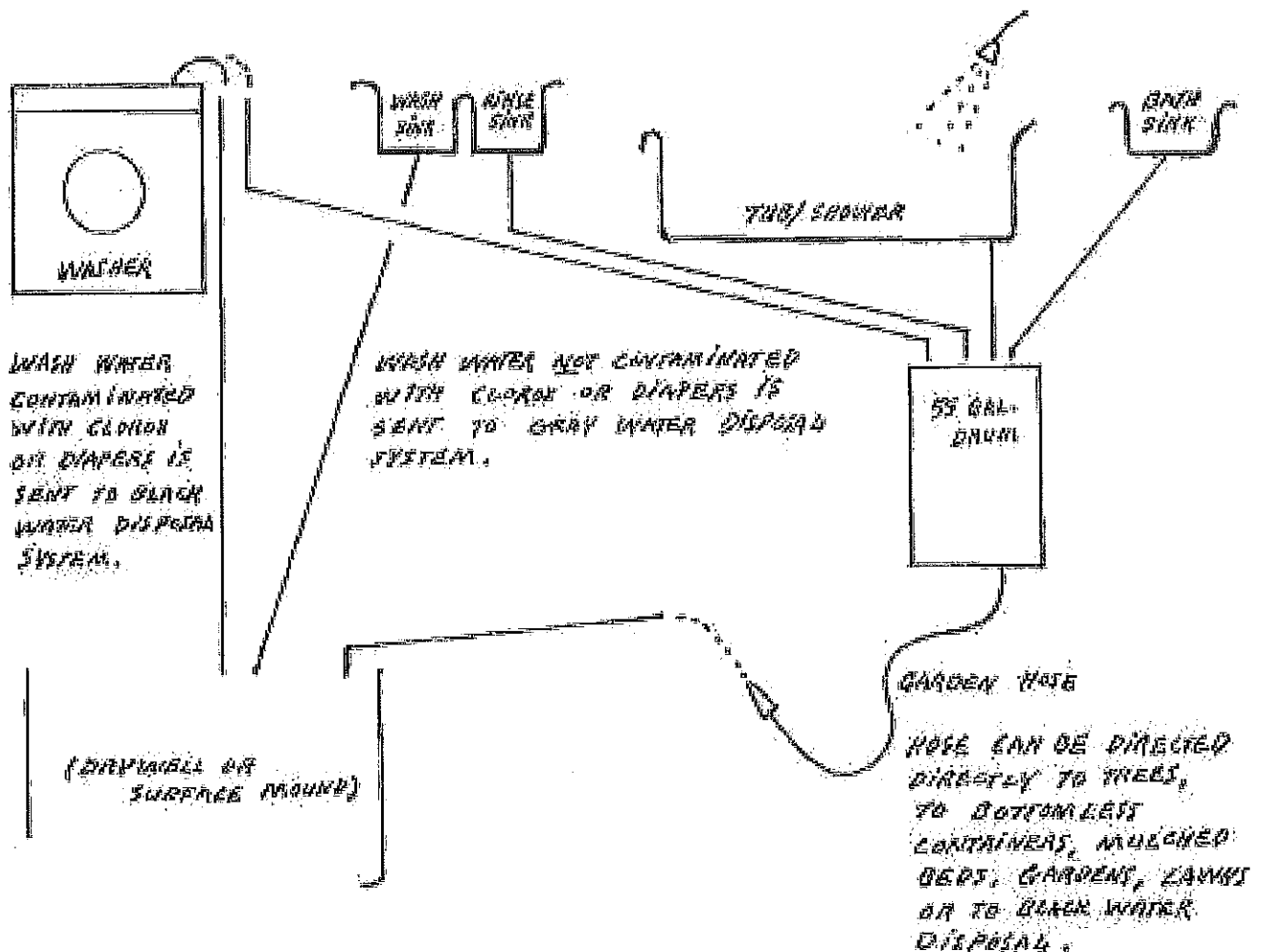

Notes:

1. 55 gallon drum is NOT a holding tank. The drum contains large volumes of water from washers and bath tubs only long enough to drain. If gray water is not needed for vegetation, water is diverted to a drywell or surface mound.
2. Wash water can be directed to black water or gray water disposal by moving drain hose.

SIMPLE, EFFECTIVE GRAY WATER STRATEGIES

Ideas for Bottomless, Vented Containers

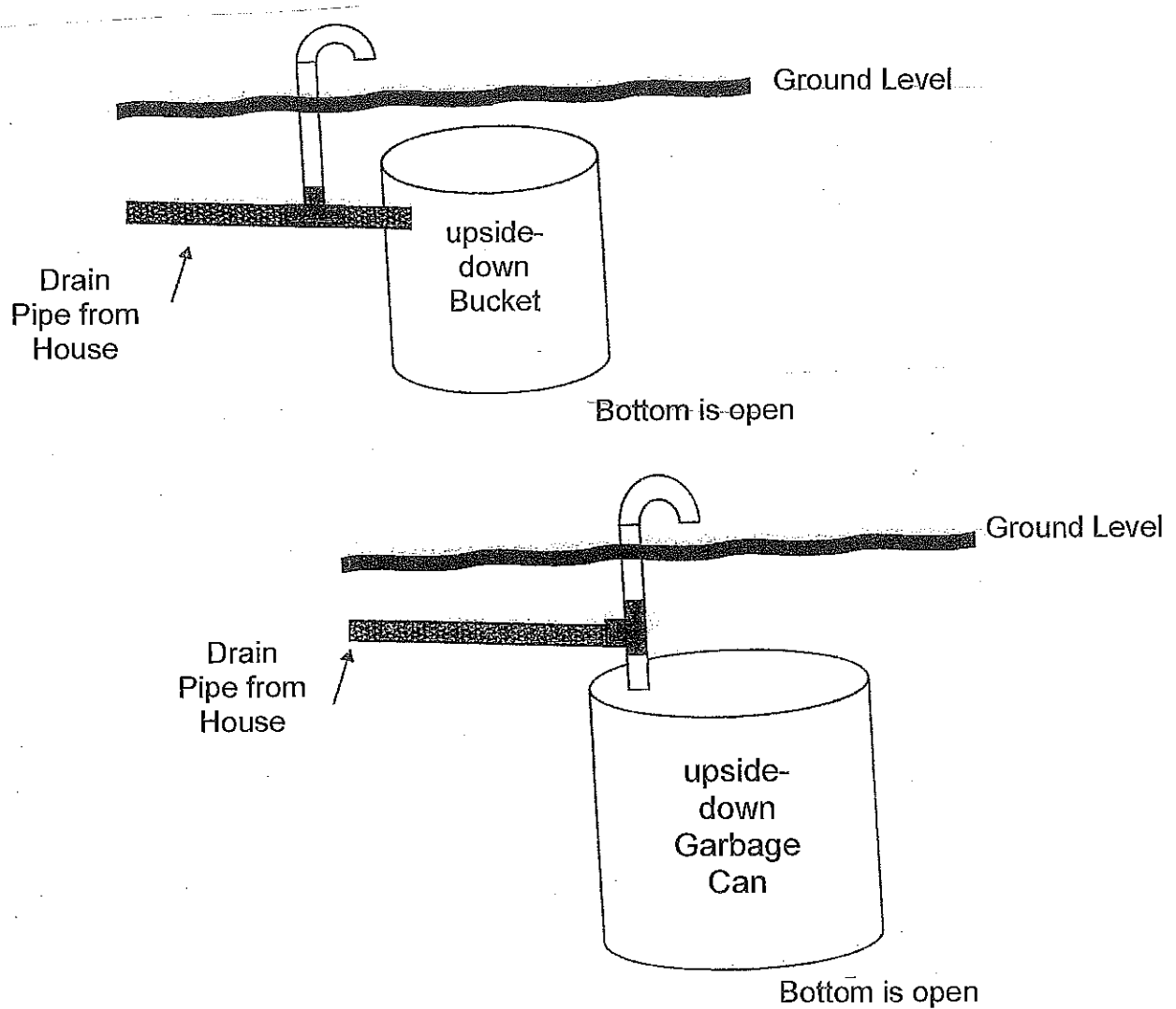

Note: These containers can be placed at the base of trees as a water source.

Note: The size of the container is determined by the water source. The container should be large enough to hold slightly more water than will usually be sent to the container.

Ideas for Bottomless Box Container

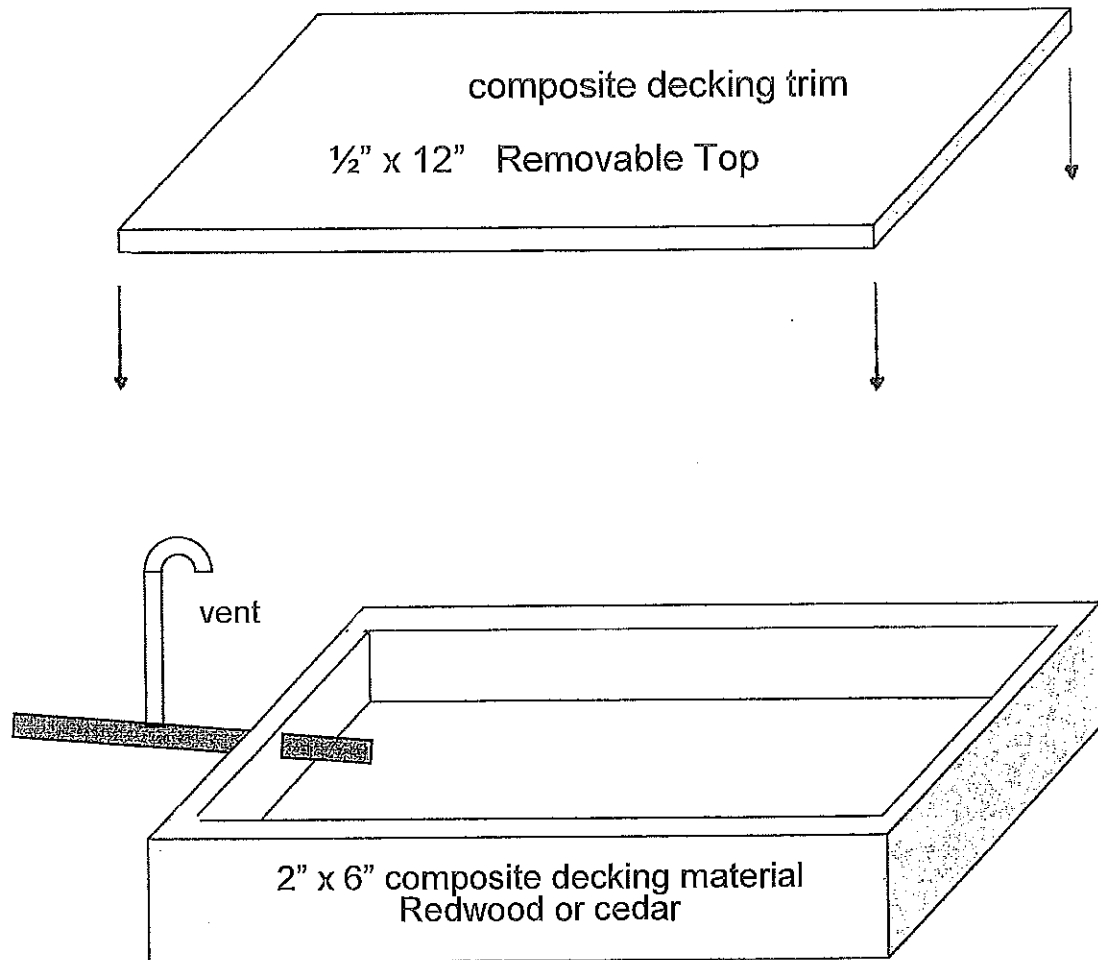

Box can be buried or sit on the surface of the ground.

Note: Plants can be placed around the perimeter of the box.

Double Kitchen Sink Arrangement

Clorox and harsh chemicals can be used in the wash sink →

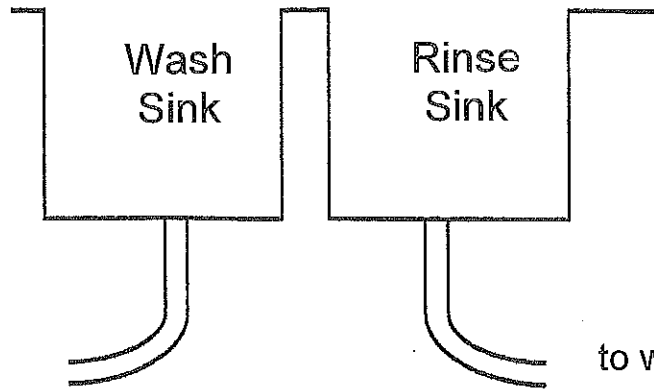

to black-water drywell or surface mound

to water trees & plants

Ideas for a Mulched Bed System

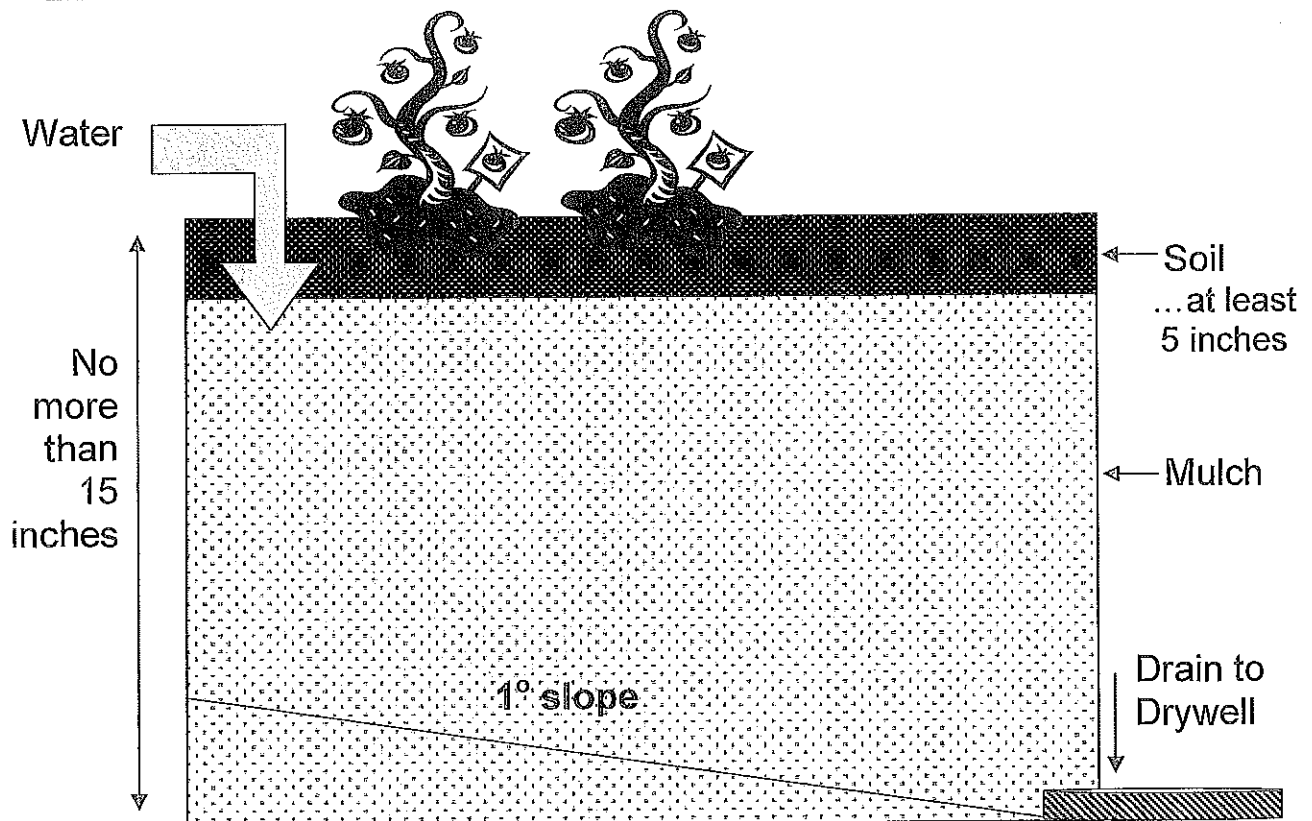

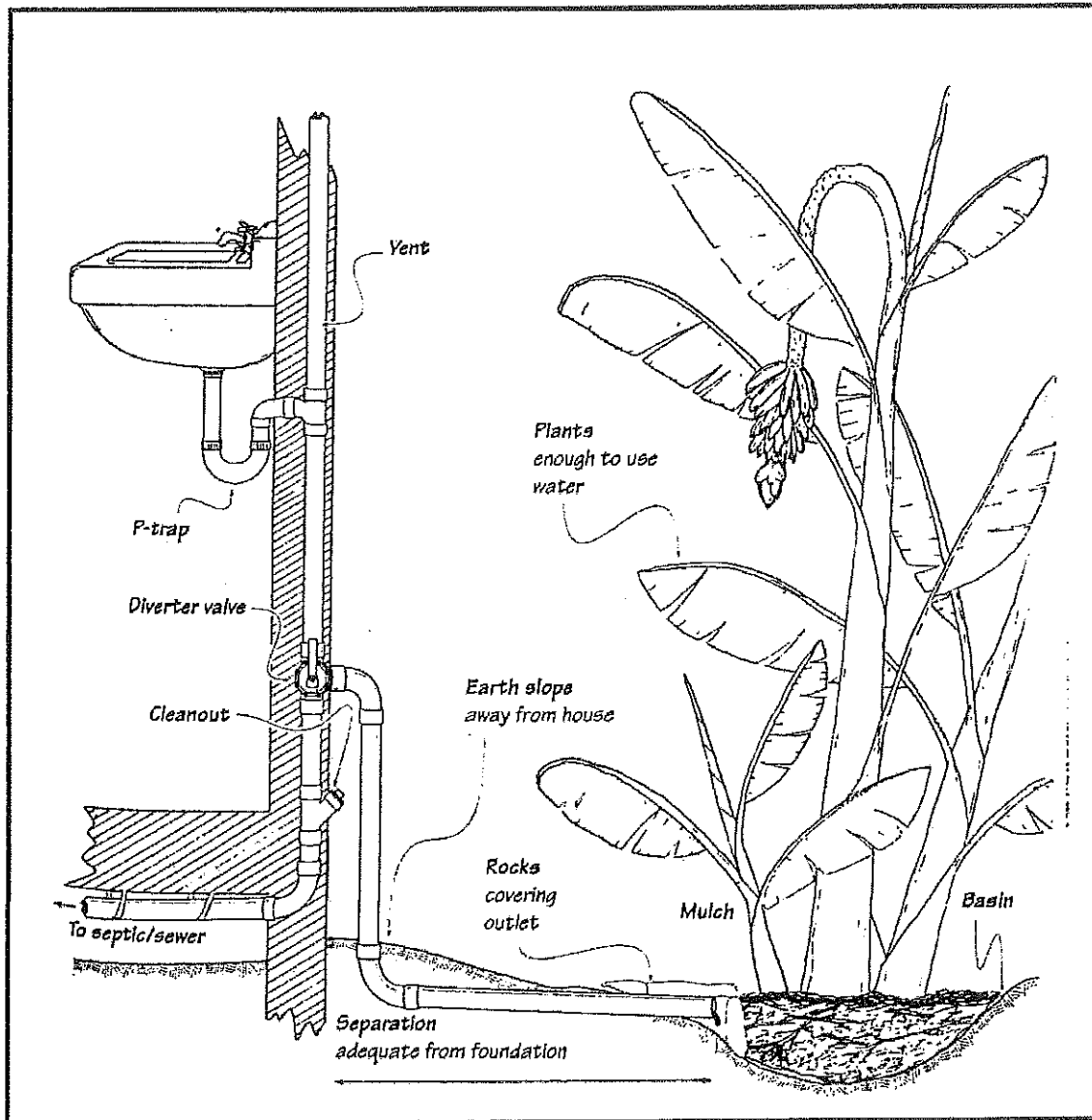

BACKHOME MAGAZINE MAR/APRIL 2007

The Drain-to-Mulch Basin option is a simple system that's built off existing plumbing and ensures a high level of treatment.

Cleaning Products That Can Be Used in Gray Water Systems

A person learns to be very careful about what types of chemicals and cleansers he puts down the drain. You cannot put anything in the water that kills bacteria. Even mouthwash can cause problems. Here is a list of products that work well with a gray water system. The list is from *Saving Water in the Home and Garden*, [see Recommended Reading]

Biocompatible Household Products:

Hand Soap

- Bon Ami Cleaning Cake (Faultless Starch / Bon Ami Co.)
- Caswell-Massey Pure Castile Soap (Caswell-Massey Co.)
- Kirk's Hardwater Castile Soap (Proctor & Gamble)
- Ivory Soap (Proctor & Gamble)
- Natural Glycerin Hand Soap (Williams-Sonoma)
- White King Natural Soap (White King Co.)

Laundry Detergent and Starch

- Ivory Snow Flakes (Proctor & Gamble)
- Faultless Starch (Faultless Starch / Bon Ami Co.)

Cleanser

- Bon Ami Kitchen and Bath Cleanser (Faultless Starch / Bon Ami Co.)
- Granny's Old-Fashioned Cleanser (Granny's Old Fashioned Products)

More Cleaning Solutions for Gray Water Systems

Here are laundry detergent choices:

1. Alfa Kleen (detergent)
2. Bold (detergent)
3. Ecover
4. ERA Plus
5. Oasis (800-225-2855 / www.bio-pac.com)
6. Shaklee
7. Yes
8. Enviro Rite Laundry Detergent (888-350-8551 / www.envirorite.com)

Note: Because they are used in such small amounts, most liquid bath products, shampoos and dish soaps pose little harm to plants irrigated with gray water.
(*Mother Earth News*, August/September 2004, p. 104)

Note: Avoid Clorox - it kills good bacteria as well as bad.

Note: Avoid mouthwash or anything antiseptic.

Note: Avoid anti-bacterial soaps.

Soaps, Detergents, and Gray Water

From *Rainwater Harvesting for Drylands and Beyond*, vol. 2, ©2009

Cleaning products labeled “biodegradable” or “natural” or even “eco-friendly” may not be gray water compatible—meaning suitable for the plants and soils of your gray water-irrigated landscape.

Gray Water Compatible Products

I prefer to use Oasis brand or Bio-Pac concentrated liquid laundry detergent and dishwashing soap; both are gray water compatible (see www.bio-pac.com). I dilute 1 part Oasis brand dishwashing soap with 8 parts water to use as a hand and body soap. For shampoo, I use Aubrey Organics brand shampoos after scanning labels to be sure there are no sodium products in the ingredients.

Traditional liquid soaps made from potassium-based ingredients such as Dr. Bonner’s liquid soaps and handcrafted liquid soaps are gray water compatible as long as they don’t contain harmful additives such as sodium salts. You can contact soap makers and ask about their ingredients.

Products and Ingredients to Avoid

- ⊗ hard chemicals such as chlorine and drain cleaners
- ⊗ bleaches and fabric softeners
- ⊗ detergents with whiteners, softeners, and enzymes
- ⊗ bar soaps and powdered laundry detergents that typically use sodium-based products as filler materials. Sodium salts can harm plants and soils. Accumulation of salts is of special concern in drylands where soils tend to be alkaline and naturally high in salts. It is wise to occasionally flush dryland soils with rainwater or other non-salty water.
- ⊗ borax and other cleansers and products made with boron. Boron is needed by plants, but only in extremely small amounts
- ⊗ soaps and detergents with the following ingredients: peroxygen, sodium perborate, sodium tryochlorite, petroleum distillate, alkylbenzene, salt
- ⊗ disinfectants

The above list of products and ingredients was compiled from State of California, Department of Water Resources (www.owue.water.ca.gov) publication *Graywater Guide: Using Graywater in Your Landscape*.

My website includes a page on gray water harvesting with more information on soaps and detergents, recommended brands, and laundry cleaning tips (www.HarvestingRainwater.com).

Recommended Reading

Know Your Graywater, David Del Porto and Carol Steinfeld. Center for Ecological Pollution Prevention, P.O. Box 1330, Concord, MA 01742, 1999.

Running Dry, Addikson and Sellick. Stein and Day Publishing, 1983.

The Composting Toilet System Book, "What About Graywater?", pp. 182,223.

Saving Water in the Home and Garden, Jonathan Erickson. Tab Books, McGraw-Hill, 1993.

Earthship III, p. 58-66.

Mother Earth News, "Tap Into Water Savings", Claire Anderson. August/September 2004, pp. 100-106.

Art Ludwig, www.oasisdesign.net

Water Storage, Art Ludwig

Harvest H2O.com (founded by Doug Pushard)

Rainwater Harvesting for Drylands and Beyond, vol. 1 and 2. Water-Harvesting earthworks by Brad Lancaster, 2009. Rainsource Press, Tucson, AZ www.HarvestingRainwater.com

The Solar Ark

**On-site food production...
(Life-support/greenhouse
module)**

SYNERGY

The more food you grow,
the less food you buy.

The more food you grow,
the less food that needs
refrigeration.

The less refrigeration needed,
the less power needed.

The less power needed,
the smaller the energy system.

Home grown food needs no
transportation –
no transportation, less expense.

STEPS ON THE PATHWAY TO ABUNDANCE

FOOD PRODUCTION

- Allow fields to lie fallow every seventh year.
Leviticus 25:3-4 For six years sow your fields, and for six years prune your vineyards and gather their crops. But in the seventh year the land is to have a Sabbath rest, a Sabbath to the Lord.
- Rotate crops.
- Create and use compost to make soil more productive. Always compost manure. Use a composting toilet or moveable arbor loo.
- Weeds are a resource. Use for compost. Composting kills weed seeds.
- Use urine for fertilizer.
- Blanket the soil with mulch to avoid sun-scald.
- Blanket the soil with mulch to increase water infiltration and retain moisture.
- Blanket the soil with mulch to discourage weeds.
- Blanket the soil with mulch to prevent wind and water erosion.
- Create biodiversity to reduce insect and disease problems.
- Create a wooded area for animal and insect habitat, increasing biodiversity.
- Contain and control animals with fencing, etc.
Genesis 1:18 Rule over...every living creature that moves on the ground.
- Guard against two-legged animals. Provide security.
Mark 12:1 ...a man planted a vineyard. He put a wall around it...and built a watchtower.
- Use a greenhouse or cold frames to start plants early and extend the growing season.
- Use low-till methods. Disturb planting areas as little as possible.
- Avoid soil compaction. Plant in planting areas—walk on walkways.

EVERY HOMESTEAD NEEDS A LIFE SUPPORT MODULE (LSM)

Primary Functions of the LSM

1. Indoor space for growing food.
2. Space protected from bad weather, insects and animal such as goats and pigs.

Secondary Functions of the LSM

1. Save garden water.
2. Captures solar heat that can be transferred to your living space.
3. Provides space for water storage.
4. Can serve as a shower and toilet space.

Designs for the LSM

Design depends upon climate

In tropical climates, all functions of the LSM can be housed in a simple greenhouse.

In climates that experience freezing temperatures, a year-round greenhouse is required for the LSM.

A solar-powered electric fence can protect a greenhouse from large animals.

LIFE SUPPORT MODULE - NOTES

1. 12-inch Super-Insulated Walls – possibly of OSB – using super-l studs and beams. Walls painted – possibly with epoxy paint to prevent moisture damage.
2. 1-inch air space to allow circulation of air.
- *3. Rain Water Storage Cabinets – 3-feet high x 2-feet wide. Lined with 6 mil. plastic. Cabinets painted black for heat absorption.
4. Drinking Water Storage – Container made of a material that will not contaminate water. Container protected from sunlight to prevent algae growth.
5. Sand Filter – for drinking water purification.
6. Wood Stove – Provides frost protection for plants. Also used for cooking and heating water for bathing. Burnable refuse disposed of here.
7. Roof Ridge Line – If pitched roof is used. Roof of fiberglass or tempered glass.
8. Gravel Floor – Space can also be used for bathing.
9. Double Glazing – Used glass or corrugated fiberglass.
10. Sheet Metal Heat Shield.
11. Rain gutters.

Caution: Floor must be built to withstand the weight of water (8 pounds per gallon).

- * Top of water storage cabinets used for plants in containers.

LIFE SUPPORT MODULE - FLOOR PLAN

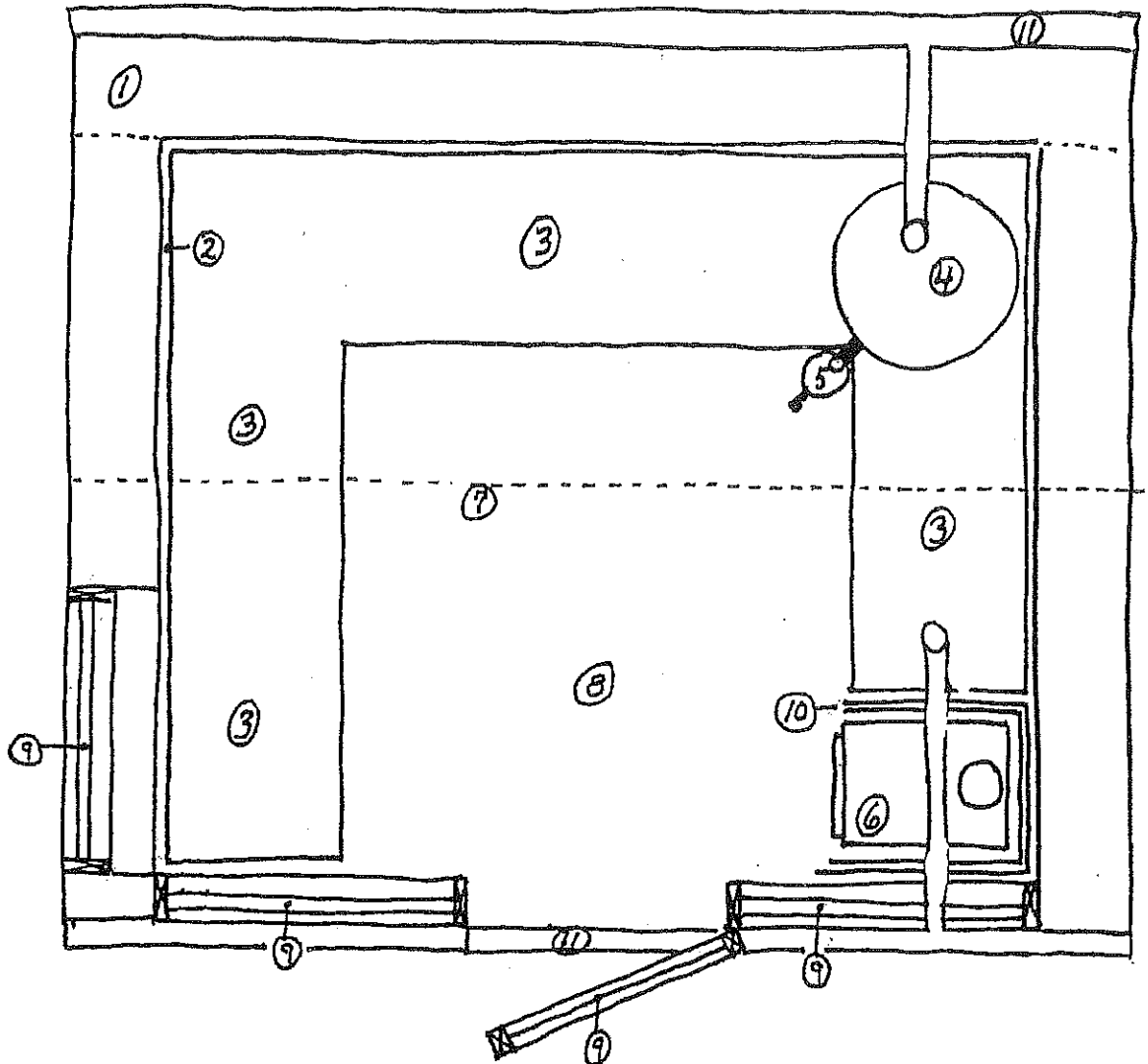

scale 1/2" = 1'

NOTES:

- | | |
|----------------------------------|--------------------|
| 1. 12-inch super-insulated Walls | 7. Roof Ridge Line |
| 2. Air Space - 1 inch | 8. Gravel Floor |
| 3. Water Storage | 9. Double Glazing |
| 4. Drinking Water Storage | 10. Heat Shield |
| 5. Sand Filter | 11. Rain Gutters |
| 6. Wood Stove | |

LIFE SUPPORT MODULE – FLOOR PLAN

An LSM for Cold Climates

(The basic idea for this LSM comes from Mike Oehler, the guru of inexpensive, earth-sheltered and underground housing. Check out his article called “Earth-sheltered Greenhouse” in *Mother Earth News*, Feb./March 2004, p. 82.)

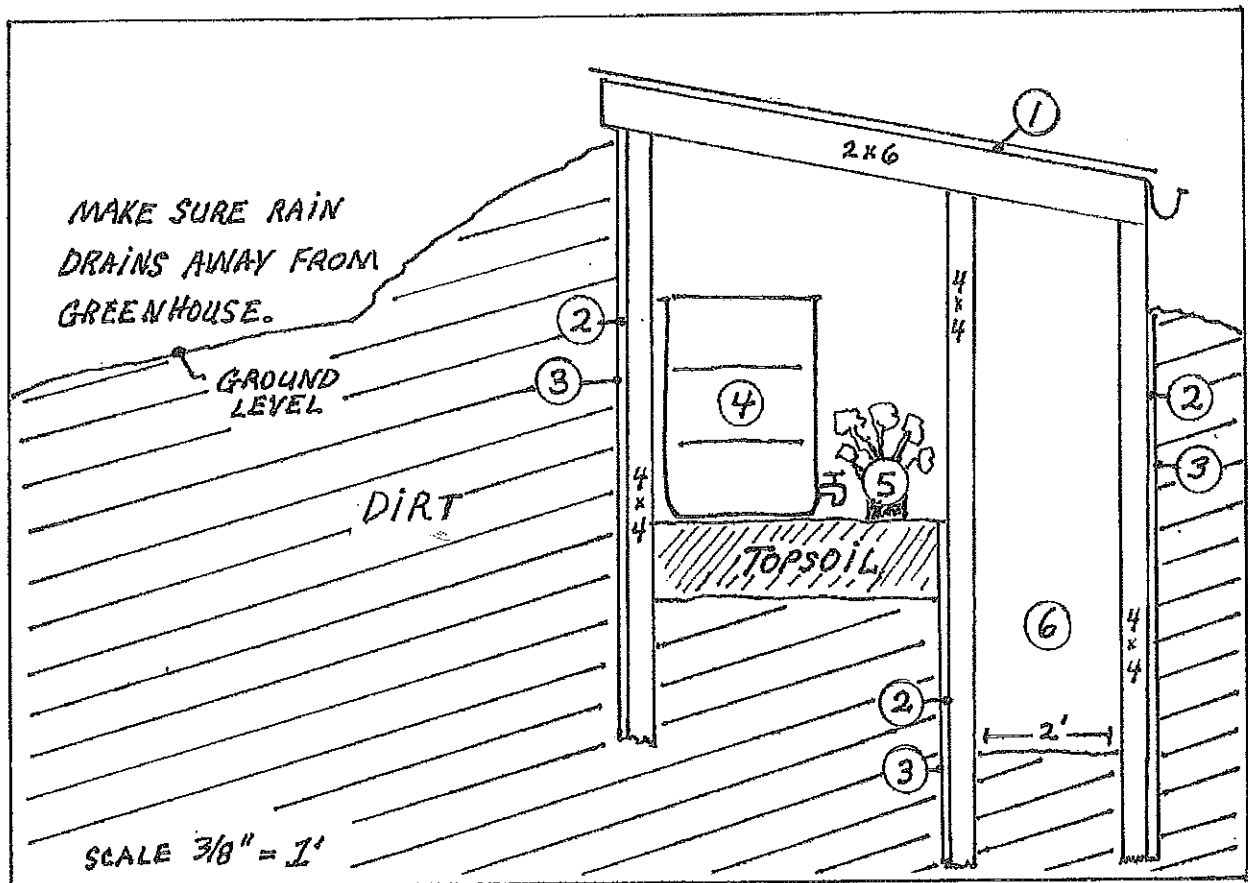

1. Translucent glazing
2. Shoring to hold back dirt
3. 6-mil polyethylene sheathing to keep out moisture
4. 55 gallon drums to hold water for plants and to moderate temperatures
5. Planting area—36-inch high and 24-inch wide for easy access
6. Cold sink-walkway. Coldest air naturally falls away from planting area.

LIFE SUPPORT MODULE

An LSM for Warmer Climates

(This plan comes from Countryside Magazine, vol. 85, no. 5, pp. 60-62. I recommend Countryside Magazine. If you can only afford one subscription, make it Countryside!)

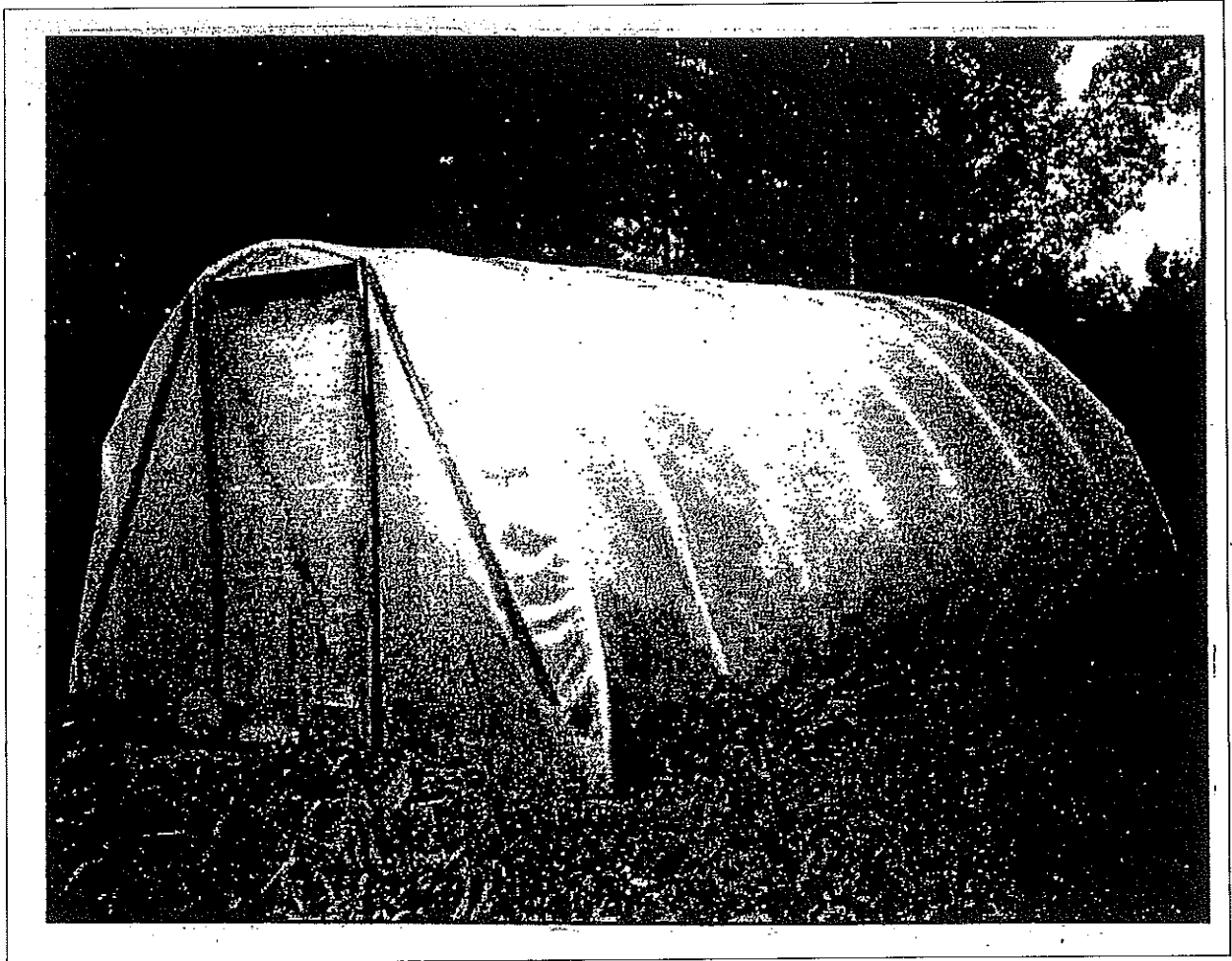

The garden:

**Build a Greenhouse for Under
\$100**

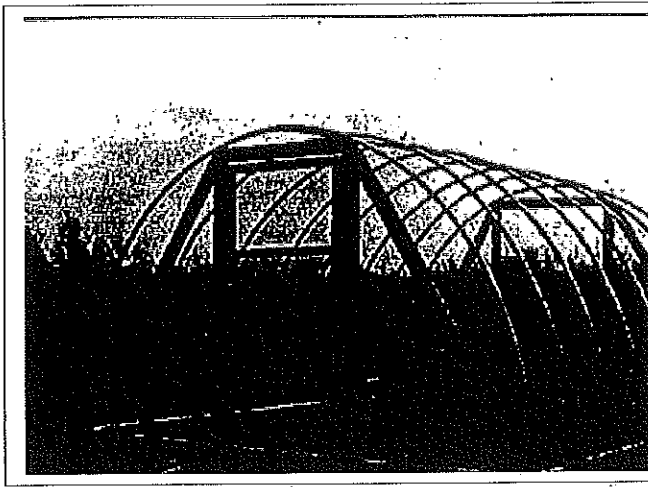

All that's needed to complete this greenhouse is a door and the plastic covering.

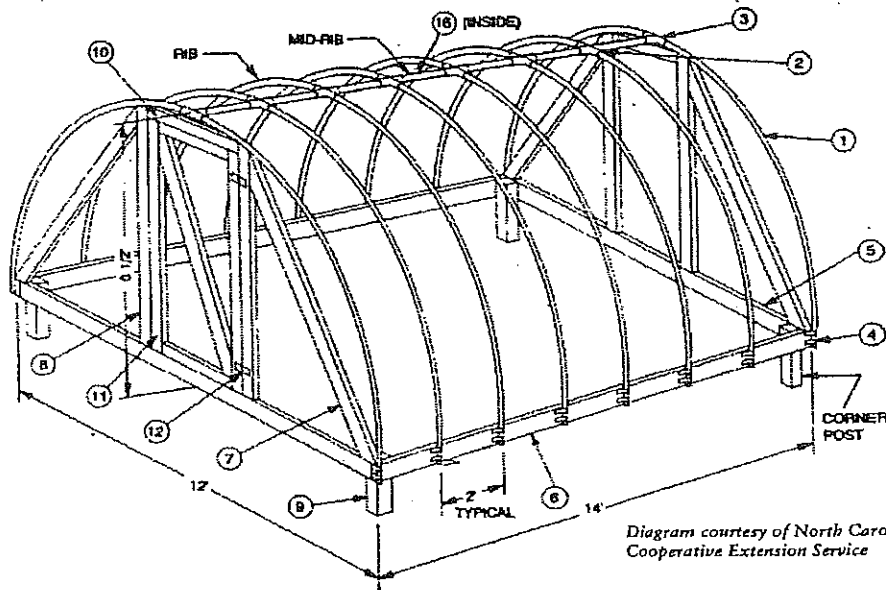
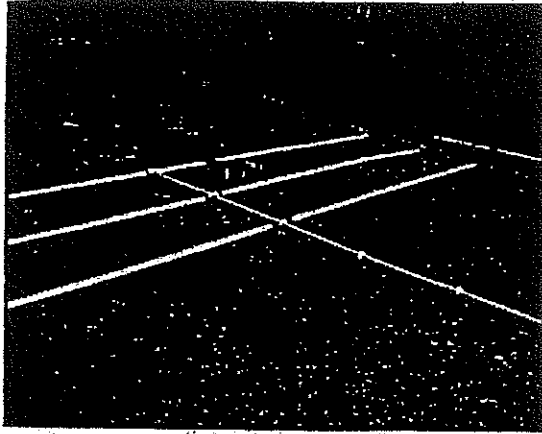

Diagram courtesy of North Carolina Cooperative Extension Service

Materials List:

Item	Quantity	Description
1.....	16	3/4-inch PVC pipe, schedule 80, 10 feet long
2.....	6	3/4-inch PVC crosses, schedule 80
3.....	2	3/4-inch PVC tees, schedule 80
4.....	32	3/4-inch galvanized electrical metallic tubing (EMT) straps
5.....	2	2" x 6" x 14' treated #2 pine boards
6.....	2	2" x 6" x 12' treated # 2 pine boards
7.....	4	2" x 4" x 7' treated #2 pine board
8.....	4	2" x 6" x 6' treated #2 pine boards
9.....	4	4" x 4" x 2' treated #2 pine boards
10.....	2	2" x 4" x 3' treated #2 pine boards
11.....	2	1" x 4" x 12' treated #2 pine boards (to be cut for door parts)
12.....	1	Set of door hinges
13.....	1	Sheet of clear plastic, 24' x 20' , 4 mil.
14.....	1	Can of PVC cleaner
15.....	1	Can of PVC cement
16.....	1	1/2" x 10' galvanized electrical metallic tubing (EMT)
17.....		Miscellaneous nails, screws, and staples



PVC ribs laid out and ready to assemble



The PVC ribs are attached to the base boards



Note: Any lightweight structure, such as this greenhouse, may need to be protected from large animals with a solar-electric fence.

PRINCIPLES OF HIGH YIELD, INTENSIVE GARDENING

1. Always compost and use your compost for gardening.
2. Use “cubed foot gardening” methods to maximize food production. Note: John Jeavors research shows that 322 pounds of fruit can be raised in 100 square feet. See Recommended Reading).
 - A. Use vertical space.
 - B. Use succession planting.
 - C. Use companion planting.
3. Use containers for gardening. Containers allow great control of water, space and soil amendments.
4. Eat as much food as possible fresh from the garden. Avoid food preservation whenever possible.
5. Extend the growing season. Use strategies to plant earlier and harvest later.
 - A. Use double-covering methods in cold climates.
 - B. Use water stored in the LSM to moderate temperatures.
 - C. Use a heat source if absolutely necessary.
6. Diversify your biosphere. Plant more types of vegetation. Try bees. Consider different types of livestock.
7. Use garden water more efficiently.
 - A. Use sub-irrigated planters.

- B. Control evaporation by using a greenhouse or mulches.
- C. Use polymers. Polymers for gardening are mixed with garden soil. They expand with moisture, holding it in the root zone.
- D. Use drip systems.
- E. Choose drought-resistant plants.
- F. Use fast-growing varieties.
- G. Apply water in measured amounts by hand.

SIP—SUB IRRIGATED PLANTER

Save water by keeping it in the root zone. Our tomato plants use 75% less water when planted in a SIP.

1. Choose a container that does not drain or leak. If the container leaks, it can be lined with a sturdy plastic bag or a piece of plastic sheathing. You can use just about any container that is large enough for your plant(s): five gallon buckets, plastic barrels, etc.
2. Divide the container into three equal sections.

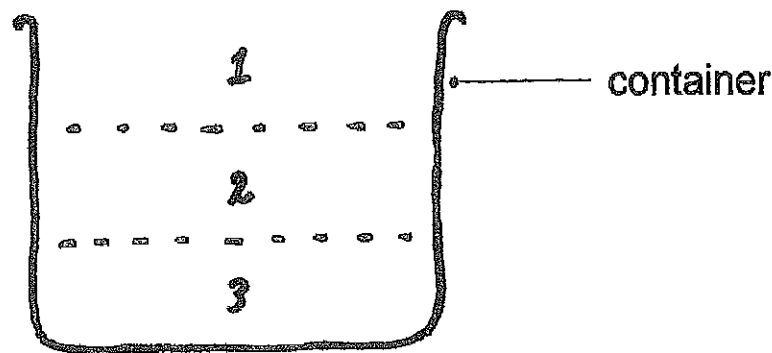

3. Place into the bottom of the container discarded plastic containers, such as pop bottles and food jars that have been drilled with many $\frac{1}{4}$ -holes. This will be a reservoir for the SIP, providing water for the plants. I place the drilled reservoir into a nylon stocking or an old sock to prevent soil from filling up the reservoir. Leave space between the reservoirs. This space will be filled with planting soil that will act as a wick to deliver the water to the plants. Looking down into the planter, the reservoirs will look like this.

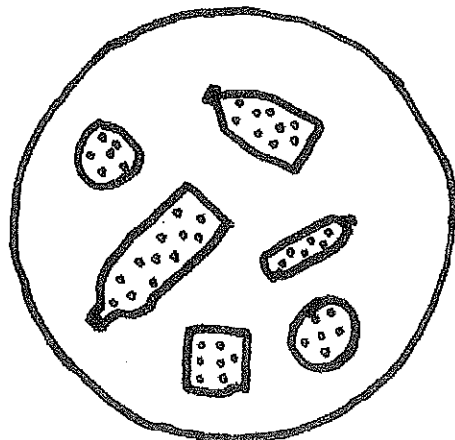

4. The other reservoirs should be no taller than the bottom third of the planter.

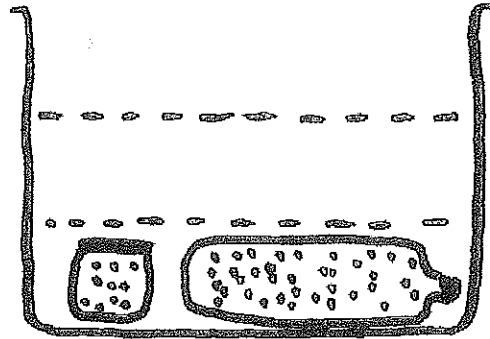

5. Drill a 1/2-inch weep hole between the second and third sections of the planter. Make sure you will be able to see the weep hole when the planter is in place.

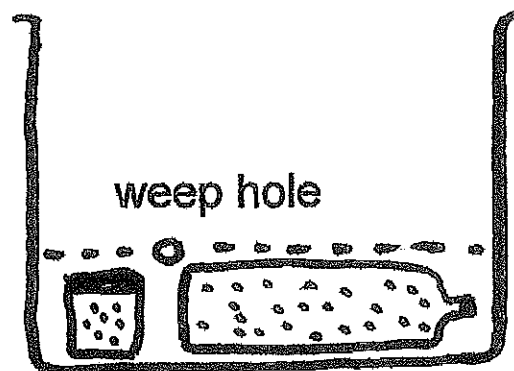

6. Place a fill-tube in the planter. Put it well away from the weep hole. You can use a tall plastic container or a piece of plastic pipe for the fill-tube. The 1/4-inch holes are only in the bottom third of the fill tube. A large tube, 3 inches in diameter or larger, will be easy to fill.

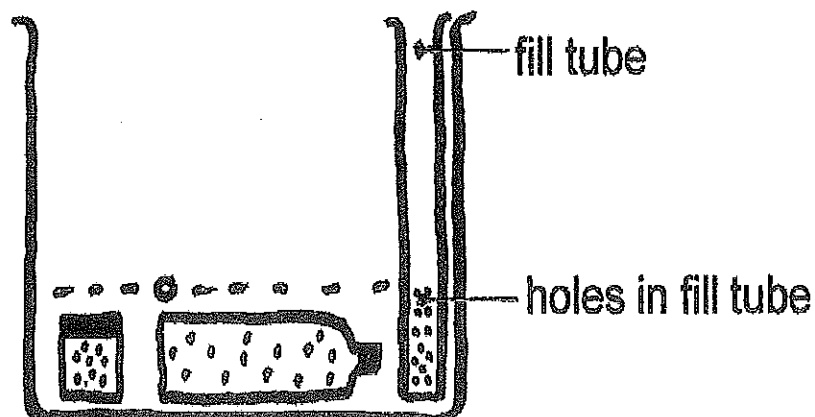

7. Fill the planter carefully with planting soil, 1 or 2 inches from the top of the planter.
8. Add water slowly through the fill tube. Fill only until water starts to come out of the weep hole. Do not overfill. Because you are using a SIP, you will need much less water. Less water will be lost to evaporation. After your plants are established, you may choose to cover the exposed soil of the planter with a piece of plastic sheathing or mulch to further discourage evaporation. You may need to keep the top of the soil moist while your seeds are germinating or when plants are first moved to the planter.

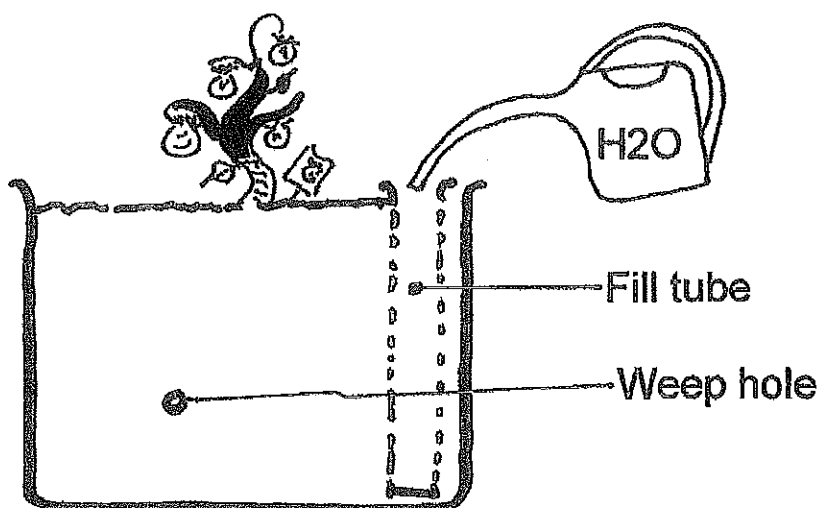

Recommended Reading

Bountiful Container, Rose Marie Nichols, McGee and Maggie Stuckey.
Workman Publications, 2002.

Cubed Foot Gardening, Christopher O. Bird, The Lyons Press, 1993,
2001.

The Vegetable Gardener's Bible, Edward C. Smith, Storey Publishing,
2000.

How to Grow More Vegetables, John Jeavors.

How to Have a Green Thumb Without an Aching Back, Ruth Stout,
Cornerstone library, 1968, 1973, 1955.

Square Foot Gardening, by Mel Bartholomew, 2006, Cool Springs
Press.

On the net: Sub-irrigated planter, SIP, 2010.

The Solar Ark...

On-site waste recycling and disposal

(composting toilet, blackwater systems)

STEPS ON THE PATHWAY TO ABUNDANCE

WASTE MANAGEMENT

- Use composting toilets.
- Send all black water to septic systems.
Note: All sewage must be managed or there will be no clean water.
- Re-use and recycle whenever possible.
- Create compost with any compostable waste. Use compost to build soil.
- Use burnable waste to heat living spaces and/or water.

KINDS OF WASTE

1. **Black Waste** - feces and urine

Disposal method - a sawdust composting toilet

2. **Black Water** - water contaminated with feces and/or urine

Disposal methods - drywell or surface mound

3. **Gray Water** - Water that has been used but not contaminated with feces or urine

Disposal method: a drywell or surface mound or used for watering plants and trees.

4. **Trash** - paper, metal, plastic, etc.

Disposal method: whatever is practical and socially acceptable

- A. Burning*
- B. Burial
- C. Sanitary landfill
- D. Recycling

* While burning, use the heat for hot water or heating living spaces. Let nothing go to waste.

STRIVE TO CHANGE WASTE INTO A RESOURCE.

BUILDING A SAWDUST TOILET

Note: If sawdust is not available, dry leaves or forest ground cover will work. Peat moss is acceptable. Even newspaper cut into confetti will work. Rice hulls, corn husks, ground straw, any high carbon, confetti-like material will work.

Materials list

- 4 or 5 5-gallon plastic buckets of exactly the same height
- plywood or 1-inch dimensional lumber
- nails and/or glue
- knobs or handles
- hinges (optional)
- toilet seat (optional)
- vent fan (optional)

Tools

- hammer
- saw
- hole saw
- square
- pencil or pen
- tape measure

Sawdust Toilet Plans

Your situation will dictate how you design your sawdust toilet. Here are ideas to consider:

1. To make efficient use of the toilet, store clean sawdust very close to the toilet.

Note: To load your sawdust bin, use a plastic bag; this won't make a dusty mess.

2. A smooth surface, painted with oil-base paint is easy to clean.
Note: Paint will yellow in the presence of the ammonia in urine.
3. The only time odor will be a problem is during and immediately after defecation. A small vent fan can solve this problem.
4. Buckets can spring leaks. I suggest placing the bucket in a larger plastic container for safety. Both are easily washed.
5. A toilet seat is a wonderful luxury. Avoid seats made of pressed sawdust or wood. The moisture from the toilet will ruin anything but a plastic seat.
6. Design a fly-proof cover for the composting toilet. Black flies are not generally a problem, but fruit flies can be a nuisance.

Using the Sawdust Toilet

1. Toilet paper will compost quickly. Avoid colors. Dyes may affect plants.
2. When defecating, turn on your vent fan. It needs to run only a few moments. If you do not have a vent fan, a scented candle can be helpful.
3. Cover feces with about 3 or 4 cups of sawdust. Use the same amount for urine. Contents of bucket shall always be moist, but not wet. If the contents become wet, add more sawdust.
4. My wife and I empty our 5-gallon bucket about once a week. Clean buckets are kept outside, but in the shade, (The sun will ruin buckets in less than a year.) The dirty bucket is washed with laundry soap (no bleach) and water. It is left outside to dry and air out. A clean bucket is placed in the toilet enclosure and lined with about 2 or 3 inches of sawdust.

OUR COMPOSTING TOILET

When people visit our home, they are usually fascinated by the solar panels and the windcharger. They comment favorably about the indoor garden and they enjoy the sunlight. If anything causes our visitors to do a double-take, it is our composting toilet. I have learned that people in most parts of the world are very sensitive about bathroom habits. There can be great resistance to any change in the bathroom. Therefore, much time was spent designing our composting toilet. Here are the criteria we developed for our waste management system:

1. The system shall be safe to operate. It shall not present unreasonable health hazards.
2. The system shall not contaminate soil or water.
3. The system shall be aesthetically pleasing, visually attractive with no objectionable odors.
4. The system shall be easily constructed by anyone with basic carpentry skills.
5. The system shall be inexpensive.
6. The system shall be easily maintained.
7. The system shall conserve water.
8. Excrement shall be rendered odorless and safe for use as fertilizer.
9. The system shall handle waste on-site. Waste shall not be transported to a distant area.

Composting Toilet

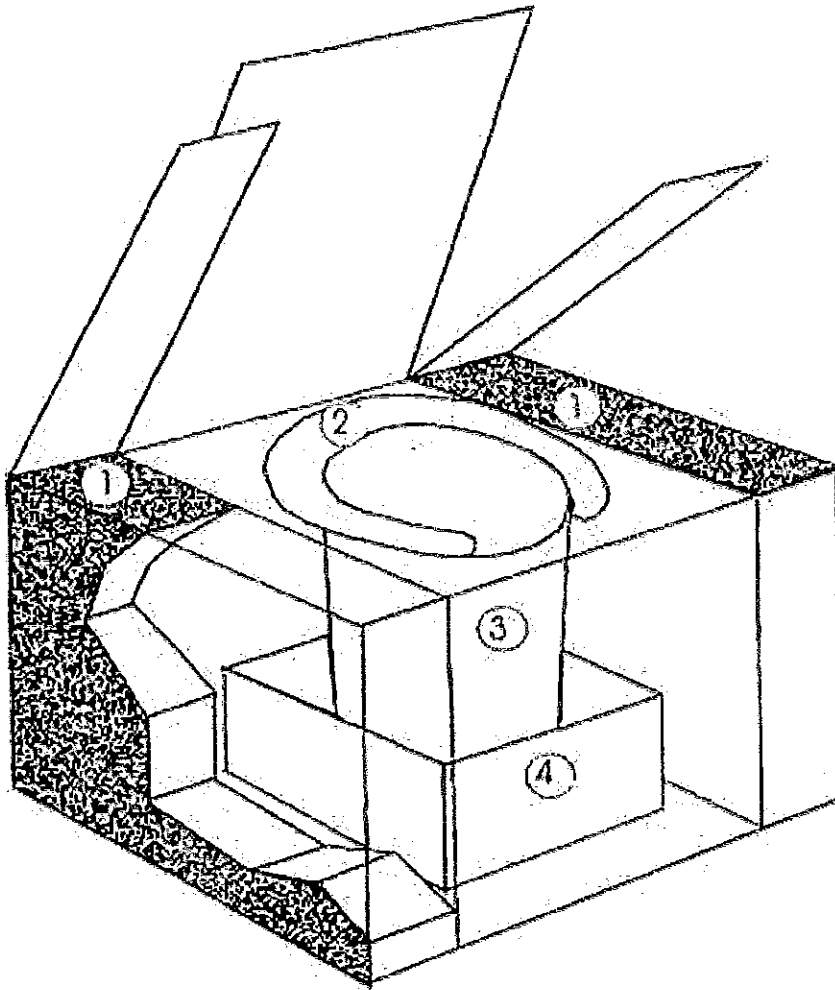

1. Covering material
2. Toilet seat.
3. Five gallon bucket
4. Plastic container.

We built our toilet for less than \$100. The components of the toilet were only about \$35, but I paid a cabinet builder to help me. The toilet consists of a box with three compartments: a center compartment that holds a five-gallon plastic bucket and a storage compartment for sawdust and leaves on each side of the bucket. I put a plastic storage container under the bucket in case it springs a leak.

LARGE CAPACITY SAWDUST COMPOSTING TOILET SUNNY SIDE ELEVATION

SCALE $\frac{1}{8}'' = 4''$

© 2007 JACK BODY

THIS IS A BASIC UNIT.
DEPENDING ON CAPACITY
NEEDED, UNITS CAN
BE CHAINED TOGETHER.

SCREENED SOLAR CHIMNEY
8" PIPE PAINTED BLACK
RUNS ON OUTSIDE OF WALL

NOTES: 1) HANDWASHING AREA IS OUTSIDE.

2) ONE SIDE IS USED WHILE THE OTHER SIDE "COOKS".

COOKING SIDE TOILET IS PADLOCKED.

3) DOOR IS SPRING-HINGED TO STAY IN CLOSED POSITION.

4) BUNKS MUST FACE SUN.

5) ACCESS DOORS

3/4" EXT. PLYWOOD.

PAINTED. MUST FIT

FLY-TIGHT.

6) EACH BASIC UNIT WILL

ACCOMMODATE 10-15

USERS.

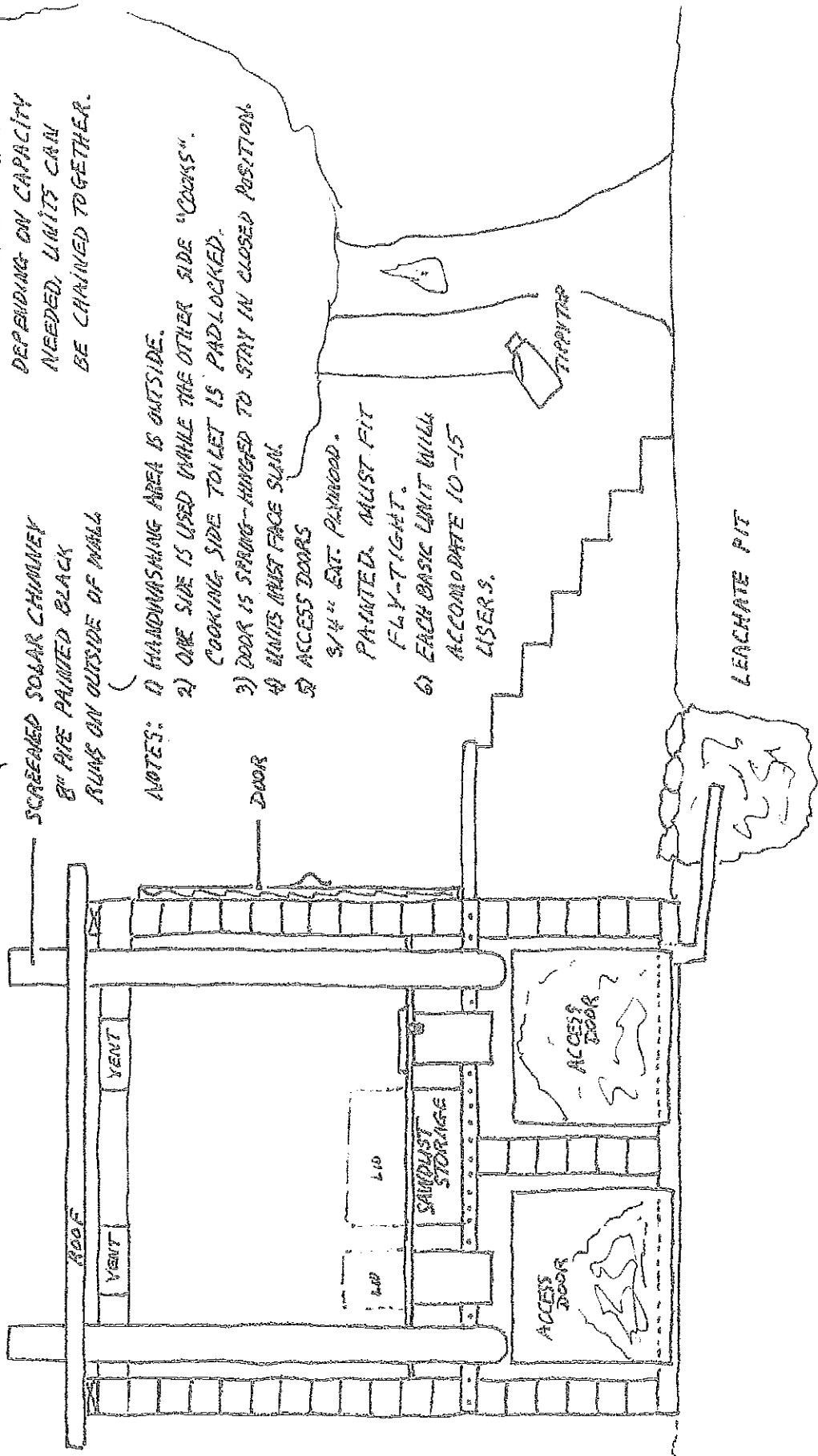

LARGE CAPACITY SANDUST COMPOSTING TOILET C/S

SCALE $\frac{1}{8}'' = 4''$
 © 2007 JACK DODY

STRUCTURE IS CONCRETE BLOCK OR COMPARABLE

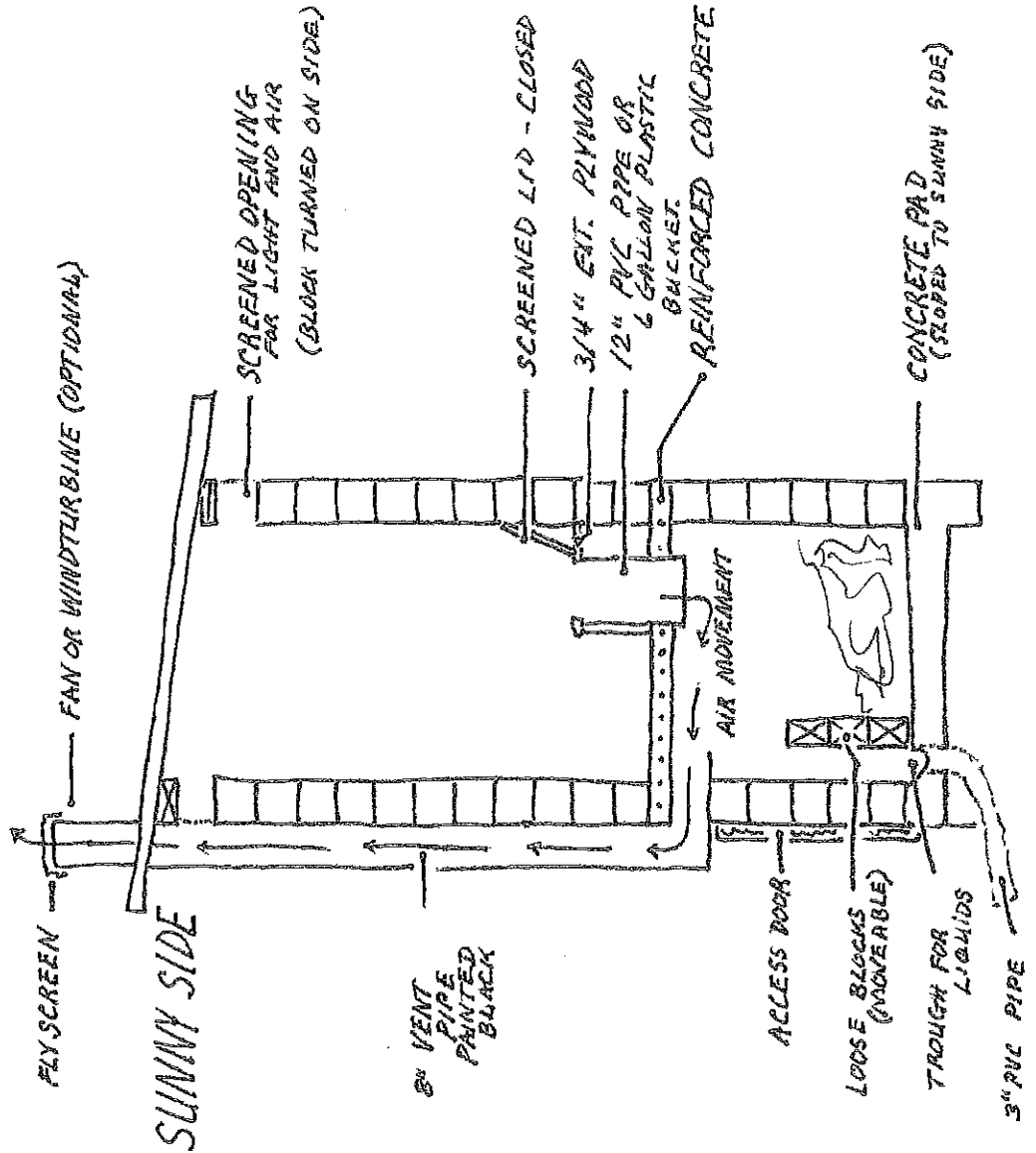

NOTES:

- 1) LEACHATE LIQUIDS DIVERTED TO A PIT - FIVE FEET DEEP, FILLED WITH WOOD CHIPS.
- 2) INTERIOR WALLS PAINTED IN EPOXY PAINT TO CREATE WASHABLE SURFACE.
- 3) ROOF MUST BE INSULATED.
- 4) VENT PIPE CREATES AIR MOVEMENT TO ELIMINATE ODORS.
- 5) WHITE TOILET PAPER IS USED.

SAWDUST COMPOSTING TOILET FOR HANDICAPPED AND SMALL CHILDREN

© 2007 JACK DODY

SCALE 1/2" = 1'

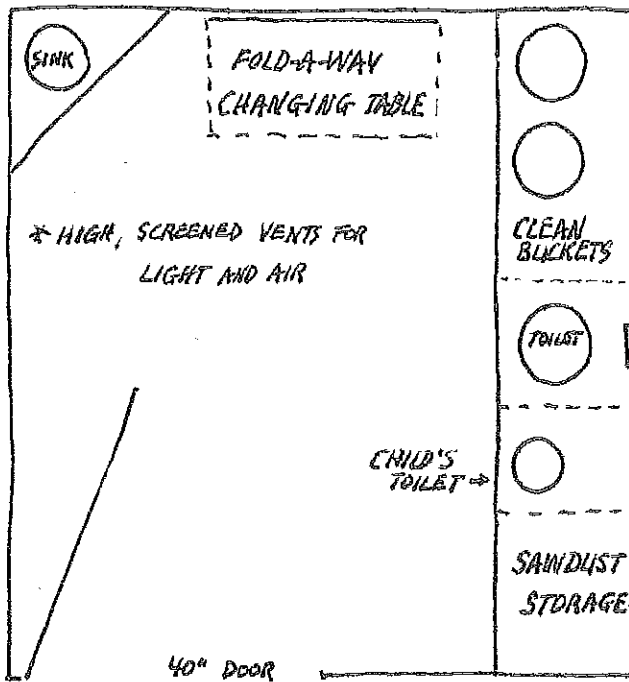

SUNNY SIDE

8" PVC PIPE - PAINTED BLACK
SOLAR CHIMNEY

NOTES: 1) CONCRETE FLOOR
2) TOILET BUCKETS
ARE EMPTIED INTO
A LARGE CAPACITY
COMPOSTING TOILET
OR ONTO A COMPOST
PILE.

RAMP
AREA

DETAILS OF TOILET BOX ADULT SIZE

SCALE 1/8" = 1"

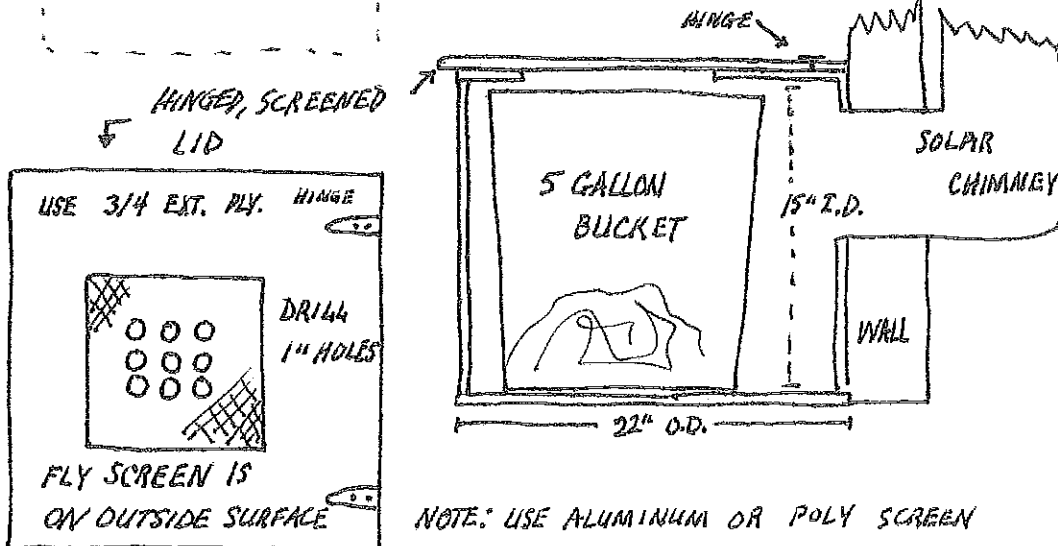

NOTE: USE ALUMINUM OR POLY SCREEN

LARGE CAPACITY SANDUST COMPOSTING TOILET ~ DETAILS

© 2007 JACK DORV

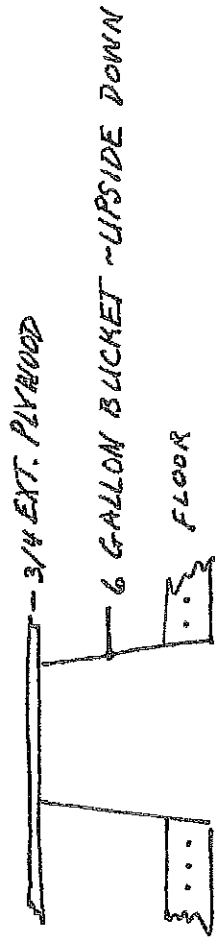

NOTES:

- 1) TOILET HOLE IS COVERED WITH A SCREENED, HINGED LIP. LIP IS PADLOCKED WHEN COMPOST BENEATH IS COOKING. OTHER TOILET IS USED AT THAT TIME.

BOTTOM OF BUCKET

CUT OUT THIS AREA

LEAVE 3/4" INCH LIP

TO ATTACH TO PLYWOOD W/ SCREWS



NOTE: HOLE CUT IN PLYWOOD SEATING AREA IS

SLIGHTLY SMALLER THAN

THE HOLE IN THE BOTTOM

OF THE BUCKET. BUCKET

IS ATTACHED TO THE

UNDERSIDE OF THE SEATING

PLYWOOD.

A Solar Ark recycles wastes...

Composting: One of God's Recycling Systems

How to Compost

1. Build enclosure(s).
2. Monitor moisture, oxygen, nitrogen (heat) and carbon.
3. Let time and microbes do their work.
4. Use compost to improve soil.

The Arbor Loo

Friends in Kenya told me about the Arbor Loo. I love the idea for its simplicity and ease of use. It is a great companion to an indoor sawdust toilet. If you live far enough in the country so that it will not create problems for your neighbors, the Arbor Loo is worth considering.

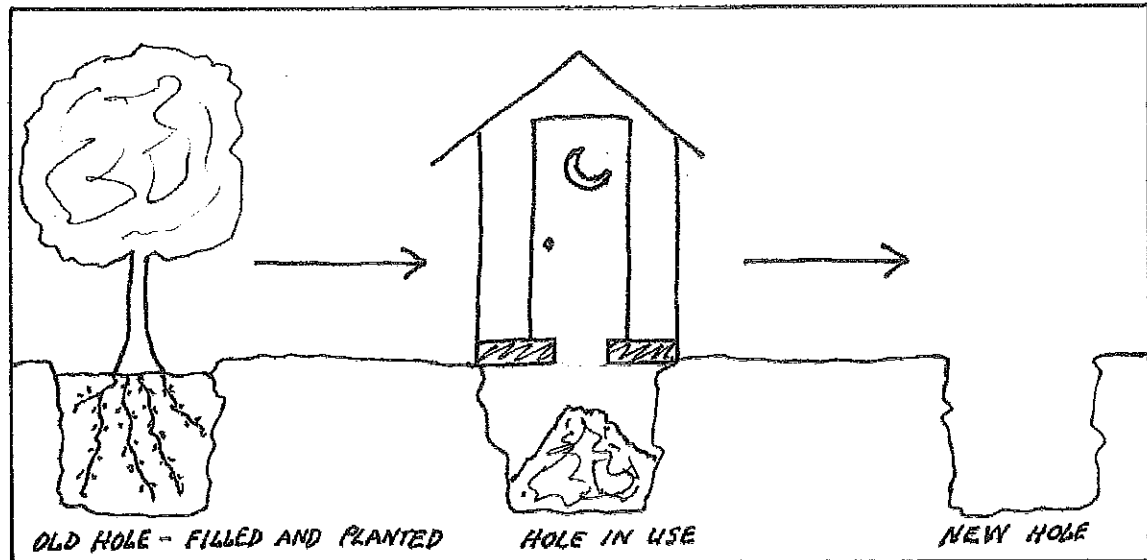

NOTES:

1. Place the Arbor Loo in an area that will not flood, at least 15 meters from any water source.
2. Dig a hole 1 meter x 1 meter x 1 meter.
3. Build a shelter (the arbor) from available materials. The base must be water and insect proof, i.e., concrete or treated lumber.
4. The shelter (arbor) is pulled over a new hole waiting for use.
5. When one hole is filled, simply move the shelter to the next hole. Immediately plant a tree in the compost of the old hole, or cover the waste with dirt. Keep animals and children away from the old hole.
6. If you use ashes or sawdust or some other high-carbon covering (see COMPOSTING), there will be minimal odors.
7. If there is a sawdust toilet inside the home, it can be dumped directly into the Arbor Loo hole.
8. The hole must always be covered—with the shelter, with dirt, or with another type of cover.

You can find excellent examples and illustrations of The Arbor Loo on the internet.

Building A Composting Enclosure

1. Choose a sunny site, out of the wind, that won't be flooded.
2. Build a three-sided enclosure that is about four feet wide, four feet deep and four feet high. Use old pallets, concrete blocks, scraps of lumber, woven-wire fencing, etc. Make sure that plenty of air can pass through the walls of the bins. It's good to have two or three bins so that one bin can be out of service and "cooking" at any time.
3. A three-sided bin is easy to fill and to turn. When the bin is full, the fourth side can be put in place to keep out animals and insects.
4. If rain makes the pile too wet, it can be covered with a tarp or straw.
5. Keep children and animals away from the compost pile. If necessary, put a fence around the composting area.

...an Easier Way to Build A Compost Enclosure

1. Turn the soil in a six foot by six foot piece of ground.
2. Place layers of material to be composted on the earth. If needed, moisten the material to be composted.
3. Cover the pile with a piece of black plastic sheathing held in place with bricks or rocks.

EXAMPLES OF COMPOSTING ENCLOSURES

Below: Several types of yard waste composters in which end-product from composting toilet systems can be further composted. (Graphics: New Hampshire Governor's Recycling Program)

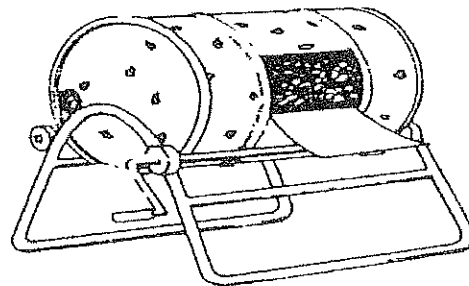
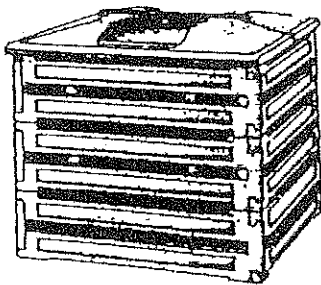
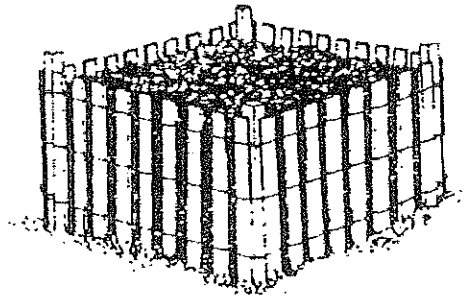
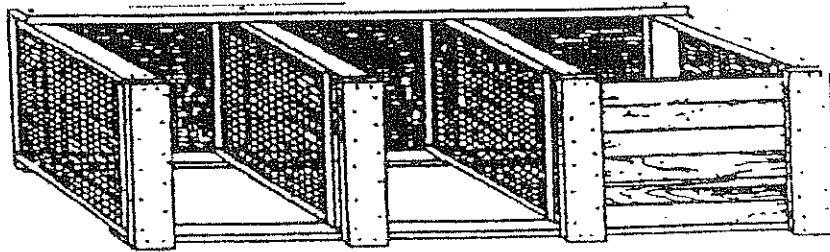
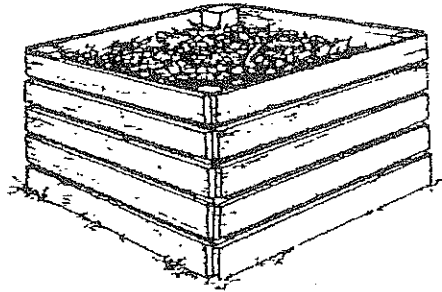
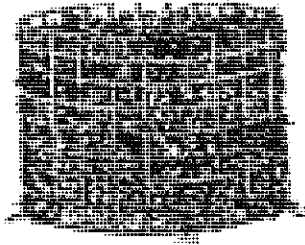

from Composting Toilet Systems, by David Del Porto and Carol Steinfeld, Chelsea Green Publishing, copyright 1999.

Starting the Compost Pile

1. Place six to eight inches of dry, carbon material (hay, straw, sawdust, dry leaves, etc.) on the bottom of the compost pile. This material will absorb excess moisture.
2. Put materials to be composted on the pile in 2 to 4 inch layers.
3. Add water to each layer if necessary.

Maintaining the Compost Pile

1. Monitor moisture. The compost pile should be as moist as a damp sponge that has been squeezed as dry as possible. If the pile becomes too wet, add dry carbon material like sawdust, dry leaves, straw, hay, etc.
2. Monitor oxygen. If the pile becomes too wet or too compacted it will be starved for oxygen. If the compost pile has a foul odor, it is not properly oxygenated. Turn the pile with a fork or a shovel. If it is too wet, add carbon material. It is good to turn the pile about once a week. Turning also distributes microbes throughout the pile.
3. Monitor nitrogen (heat). **A properly functioning compost pile will reach temperatures of 130 -165 degrees Fahrenheit. This heat kills pathogens that are harmful to humans,** if the pile is not becoming warm, add nitrogen (cured manure, clover, pea plants, ammonium nitrate, ammonium sulfate, high-nitrogen fertilizer without pesticide, or grass clippings. Follow instructions in "Things to Compost".) If the compost pile becomes smelly and it is not too wet, there is too much nitrogen. Add carbon material to balance the nitrogen. In very cold weather the pile will go dormant. It will function again when temperatures rise.
4. Monitor carbon. Carbon helps maintain the pile's balance. If the pile is too wet, too compacted or too smelly - add carbon,
5. Cover anything that will attract insects or animals with straw, hay or sawdust.

Things to Compost:

1. The contents of composting toilets
2. Autumn leaves from deciduous trees
3. Dead annuals and perennials
4. Pruned twigs cut short (less than a pencil in diameter or shredded)
5. Workshop sawdust or shavings (Because they are woody, add extra nitrogen.)
6. Lawn clippings (Must be carefully mixed into pile to avoid clumping. Use sparingly.)
7. Vacuum cleaner dust
8. Leguminous plants of the pea family that add nitrogen to the soil and compost: clover, pea vines, etc.
9. Vegetable leftovers from kitchen: coffee grounds, tea leaves, pasta and bread, eggshells
10. Finely-shredded brown paper bags, cardboard, and newspapers (No slick or colored papers)
11. Lake plants or seaweed
12. Hay or straw
13. Old manure from rabbits, goats, cows, poultry, pigs, sheep and horses (Use about a 2 inch layer as often as needed to raise nitrogen levels.)
14. Cornstalks and tomato vines
15. Ammonium nitrate, ammonium sulfate, or an inexpensive high-nitrogen lawn fertilizer without pesticide (Sprinkle the pile with 1/3 to 1/2 cup of fertilizer per 25 square feet of surface area.)
16. Hair—mix it thoroughly to avoid clumping.

Things Not to Compost

1. Oak, holly, or conifer leaves (These are acidic and more resistant to decay.)
2. Toxic plants: eucalyptus, poison oak, poison sumac, black walnut
3. Plants with thorns
4. Wood byproducts from lumber treated with wood preservative chemicals
5. Aggressive weeds such as Bermuda which sprout runners and roots
6. Bones, meat, grease, and other animal products
7. Any manure from dogs, cats or other carnivorous animals (Pathogens from carnivores can be difficult to kill and can cause illness in humans.)
8. Clorox, anti-bacterial soaps or toxic cleaning products, mouthwash
9. Any plants, plant parts or soils that show signs of disease, pests, or any undesirable webby mycelia of soil fungi
10. Ashes—save them to sprinkle directly on plants that need more alkalinity.



Sterile urine is a good source of nitrogen, phosphorous and potassium, and can be diluted with water at a ratio of 1-to-10 to help your garden grow.

Finally: Don't Flush that Fertilizer!

Consider buying a composting toilet to keep blackwater, which contains the most potential pathogens, out of wastewater entirely. In some states, installing a composting toilet allows you to construct a smaller, less expensive leach field.

If your state doesn't yet permit composting toilets, instead of flushing urine down the drain, where it pollutes waterways and chokes off ponds and lakes, you easily can capture urine's valuable nutrients to enrich garden growth and boost backyard compost-bin activity.

All you need is a funnel, a container for collection, like a plastic gallon milk jug, and some plants or a compost pile to water. Or you can just pee into a bucket, then use the urine immediately. For vegetables, fruit trees or anything else on which you want to encourage rapid, green growth, dilute urine with water at about a 1-10 ratio and pour it around the plant roots. Dilute urine also is an excellent addition to a compost pile

that is carbon-rich, but nitrogen-poor. The urea in urine helps break down lignin, accelerating the decomposition of woody materials.

Urine constitutes the bulk of human excrement and also contains most of the nutrients. The nitrogen, phosphorous and potassium found in urine are available in ideal chemical forms for plants. And urine is virtually free from the heavy metals that may be found in many commercial fertilizers.

Unlike feces, urine is commonly sterile. Pathogens that may be transmitted through urine, says Caroline Schönning of the Swedish Institute for Disease Control, are rarely sufficient to cause a significant public health problem. When urine is used in temperate climates, she says, it is not considered a health risk. ☺

Carol Steinfeld is projects director for the Center for Ecological Pollution Prevention in Concord, Massachusetts, and co-author of *The Composting Toilet Systems Book*, on MOTHER's Bookshelf, Page 103. She most recently co-authored "Water-Wise Toilets," in MOTHER EARTH NEWS, June/July 2002.

Recommended Reading

(Note: All composting information came from the following sources. I rearranged and edited the information, often using the original authors' words. Jack)

The Budget Gardener, Maureen Gilmer, Penguin Books, 1996, p.34.

Compost the Quickie Way, Lynn Gordon Stetser, Jr., Backwoods Home Magazine, p. 16.

The Composting Toilet System Book: A Practical Guide to Choosing, Planning and Maintaining Composting Toilet Systems, by David Del Porto and Carol Steinfeld.

For Good Compost Every Time, Tom R. Kovach, Backwoods Home Magazine, Sept./Oct. 1998. p. 21

Hints for the Vegetable Gardener-A to Z, R. Sanders, Garden Way Publishing, 1976.

The Rodale Book of Composting, Deborah L. Martin and Grace Gershung, editors, 1992 Rodale Press

On the net: The Arbor Loo

On the net: The Sawdust Toilet

A Solar Ark Recycles Wastes...

BLACK WATER DISPOSAL

(Black Water is water that is contaminated with urine, feces or harsh chemicals.)

Black water can be safely disposed of in a dry well, surface mound or septic system.

SOIL PERCOLATION TEST FOR BLACK WATER DISPOSAL

Note: Before you decide on an appropriate disposal system for black water, you must know how effectively your soil filters water. A percolation test provides this information.

1. There shall be one test hole for every 1200 square feet of absorption area. (Note: For most Solar Arks, one test hole will be adequate. A Solar Ark should generate little waste water.)
2. The test hole shall be at least 50 feet from any water source. Avoid flood plains.
3. The test hole shall be at least 6 feet deep.
NOTE: For a surface mound, the test hole is only 14 inches deep.
4. The test hole shall be 6 inches in diameter, or as close thereto as possible. (A standard post-hole digger will create a properly-sized hole.)
5. On the night before the percolation test, fill the test hole with 14 inches of water.
6. On the day of the test, the test hole shall be refilled with at least 14 inches of water. When the water drops to 6 inches, begin to measure the time it takes for those last 6 inches of water to be absorbed.

A percolation rate of between 5 and 60 minutes per inch is desired. It should take 30 minutes to 6 hours for the water to be absorbed.

Idea for the Soil Perc. Test Hole

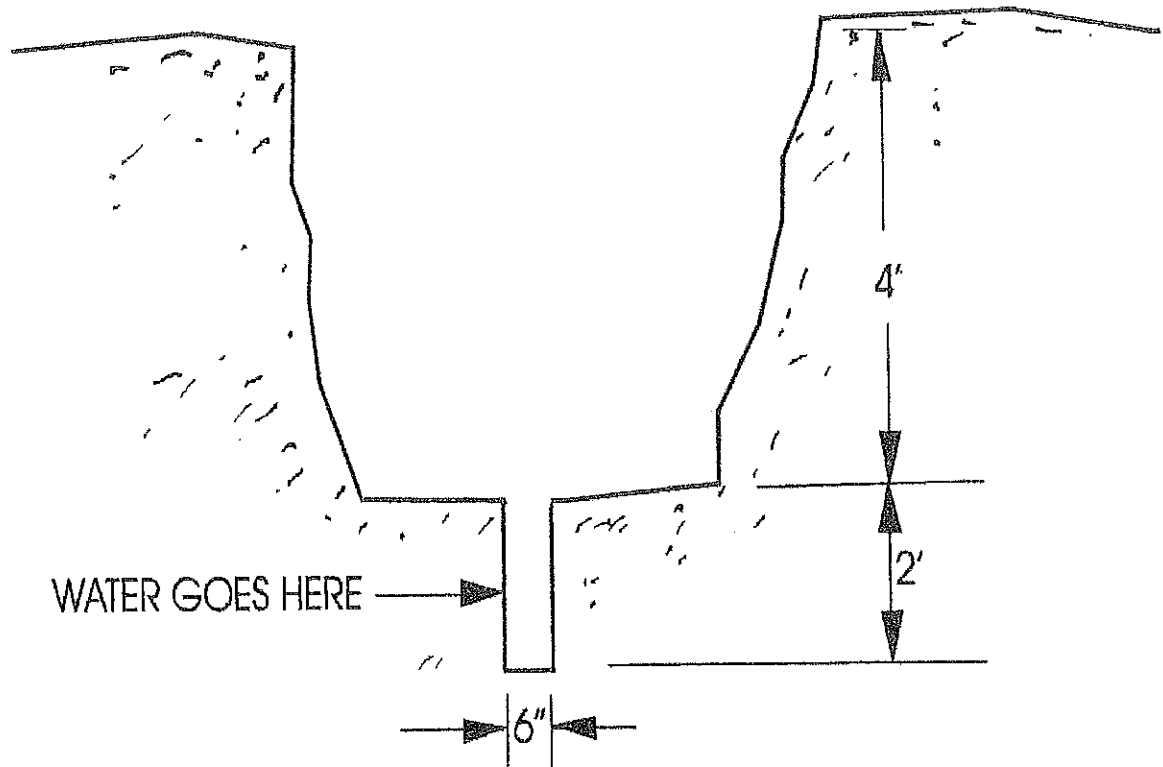

1. Locate black water disposal at least 50 feet from any water source.
2. Dig a hole 4 feet deep and as small as is practical with pick and shovel.
3. Dig two feet more with a post-hole digger.

(Note: If your perc. test is acceptable, consider building a drywell.)

Possible Perc. Test Problems

Problem #1 - The soil is too rocky to dig.

Problem #2 - The soil has too much clay and the water cannot percolate through it. (It takes more than 6 hours for the test hole to empty.)

Problem #3 - The test hole fills with ground water.

Problem #4 - The water empties out of the test hole too quickly. (It takes less than 30 minutes for the hole to empty.)

To solve these problems, build a surface mound.

Solutions for a Bad Perc. Test...

Principles for Building a Surface Mound

1. Locate the mound at least 50 feet from any water source. Avoid flood plains.
2. Locate the mound away from trees.
3. Level the ground.
4. Create a void or open space that is capable of holding slightly more than the amount of water that typically will be sent to the mound.

Example: You are building a mound for your washing machine. You want to be able to dispose of the waste water from two loads of laundry, about 70 gallons. The void under the mound must be able to hold at least 70 gallons.

5. Always create a vent so that water can enter the void.
6. Cover the void so that it cannot be filled with soil. Use old carpet, corrugated galvanized sheet metal, cardboard, cloth, blankets, plastic sheathing, etc.
7. Use enough sandy soil on the mound to absorb all the moisture of of the mound. If the soil of the mound becomes wet, add more soil to the mound or send less water to the mound.
8. Build a fence around the mound to restrict children and/or animals.
9. Plant flowers with non-invasive root systems on the mound.

Black Water Mound Idea #1

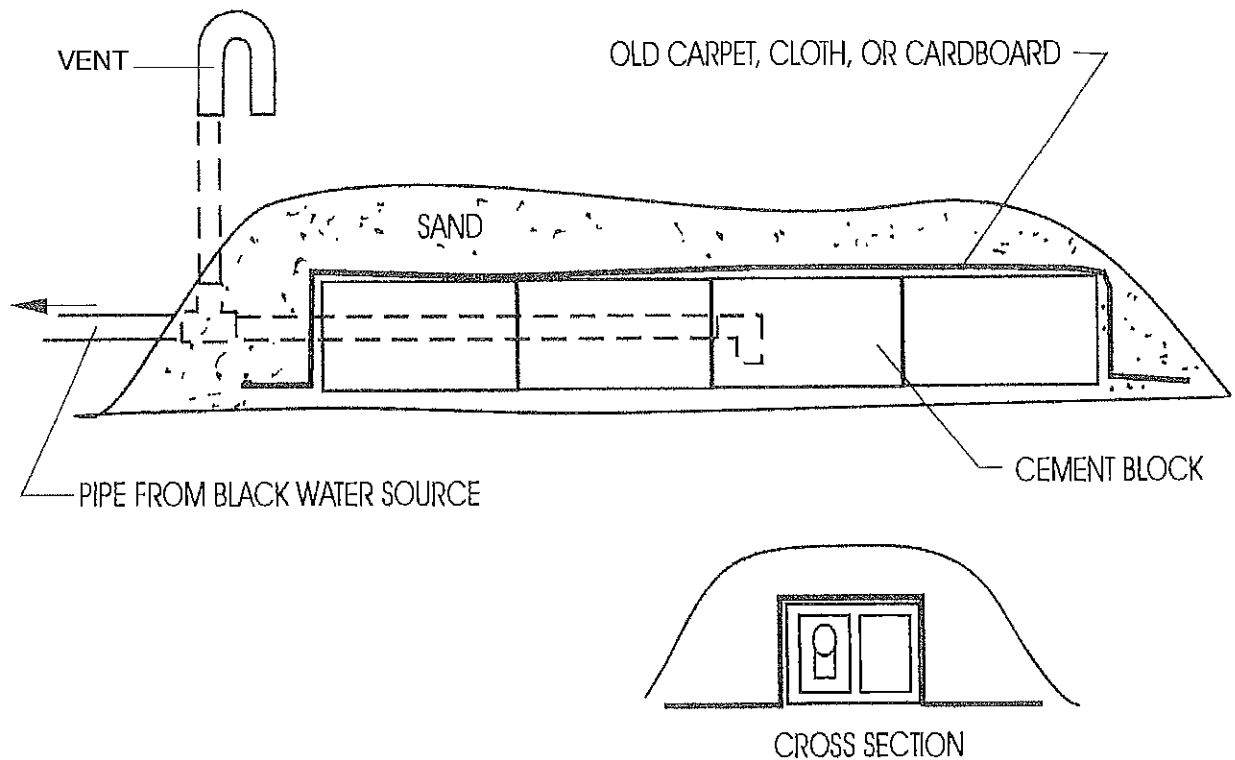

1. Place concrete blocks on the ground to create a void.
2. Extend the drain pipe to the center of the blocks.
3. Create a vent.
4. Cover the blocks with corrugated galvanized sheet metal, old carpet, cloth, cardboard, blankets, plastic sheathing, etc. so that soil cannot fill in voids.
5. Cover the blocks that are covered with old carpet, plastic sheathing, etc., with sandy soil..
6. Put a fence around the mound.
7. Plant flowers!

Black Water Mound Idea #2

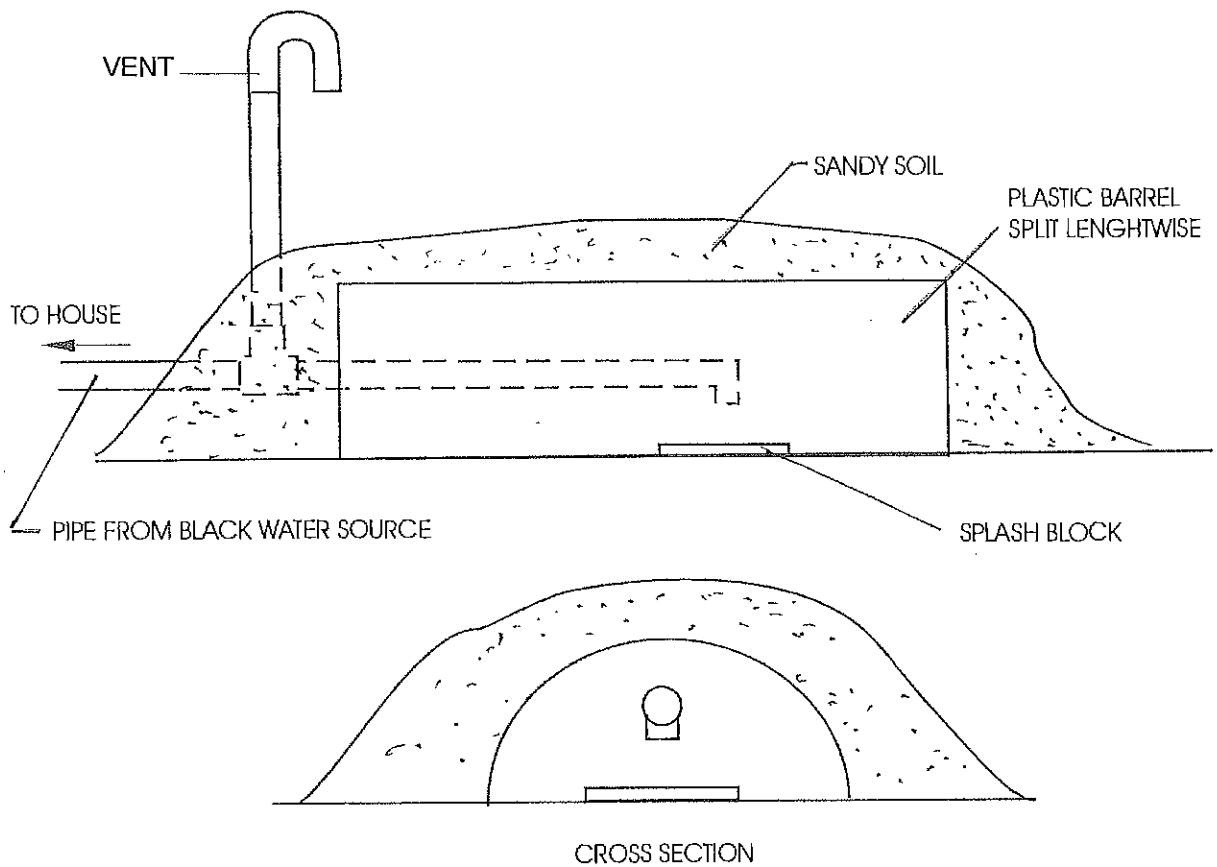

1. Place a plastic 55 gallon drum, split lengthwise, on the ground to create a void. Substitute an old bathtub, stock tank, sink, etc.
2. Extend a drain pipe to the center of the void. Place a splash block at the end of the drain pipe.
3. Create a vent.
4. Cover the 55 gallon drum, bath tub, stock tank, sink, etc. with sandy soil.
5. Put a fence around the mound.
6. Plant flowers!

Black Water Mound Idea #3

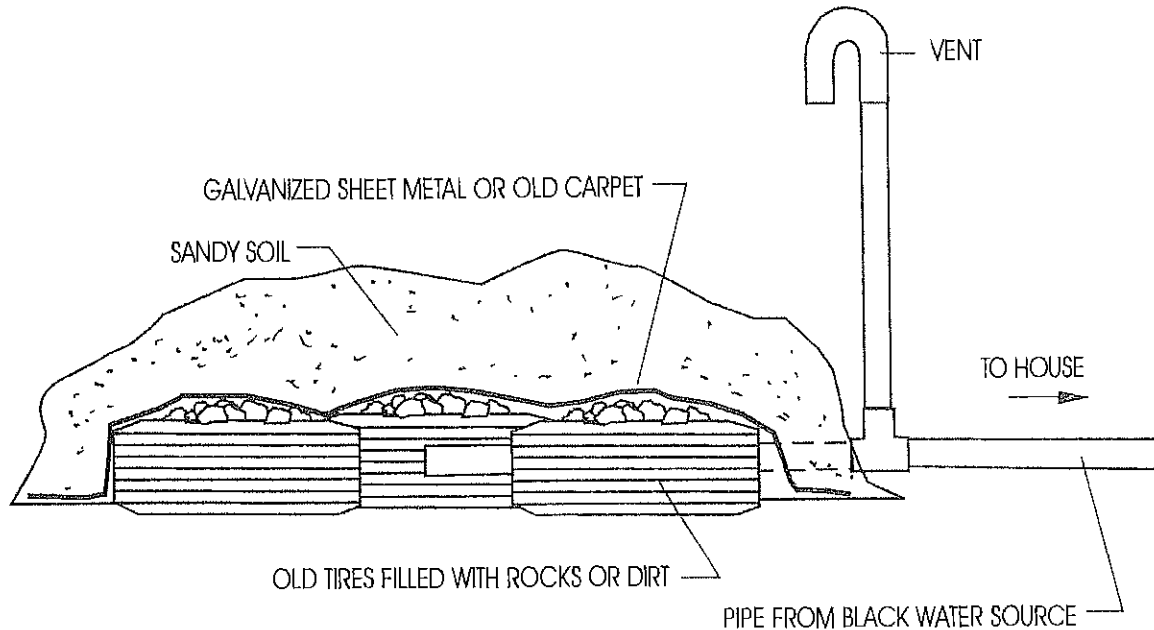

1. Use old tire(s) to create a void.
2. Extend a drain pipe to the center of the void. Place a splash block at the end of the drain pipe.
3. Create a vent.
4. Use galvanized, corrugated sheet metal, old carpet, plastic sheathing, etc. to cover the tires and keep soil out of the void.
5. Cover the galvanized, corrugated sheet metal, old carpet, plastic sheathing, etc. and tires with sandy soil.
6. Put a fence around the mound.
7. Plant flowers!

Black Water Mound Idea #4

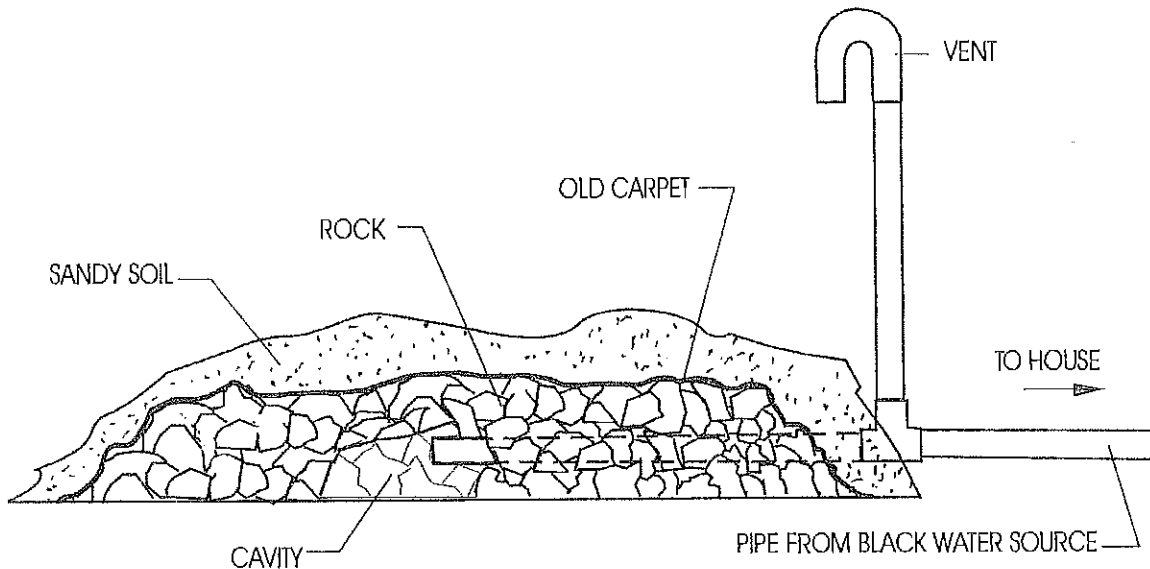

1. Use rocks of uniform size (at least fist size) to create a void.
2. Extend a drain pipe to the center of the pile of rocks.
3. Create a vent.
4. Cover the pile of rocks with old carpet, cloth, cardboard, blankets, plastic sheathing, etc. so that soil cannot fill the void.
5. Cover the pile with sandy soil.
6. Put a fence around the mound.
7. Plant flowers!

Constructing the Dry Well

(If your perc. test is acceptable, you may choose to build a dry well.)

What it is: A covered pit that will allow water to seep into the earth, thus filtering and purifying it.

Materials needed:

- Old tires
- Old cardboard, plastic sheathing, carpet, etc.
- PVC pipe and fittings

How to construct a dry well:

1. In an area away from trees, dig a pit just a bit wider than the diameter of the tires being used.

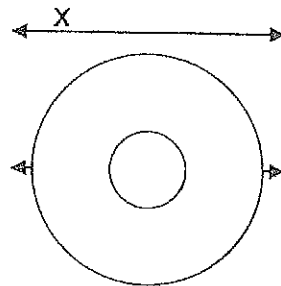

2. The pit should be deep enough to allow water to drain to the pit at the rate of 1/4 inch per foot.

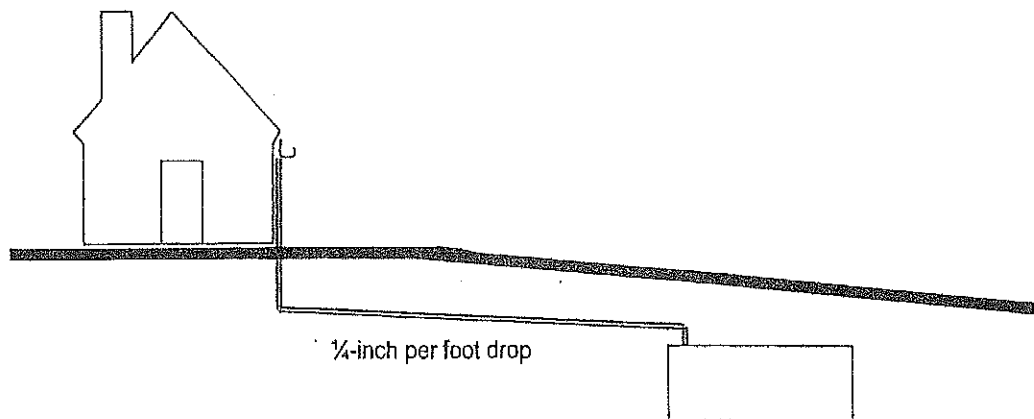

Plumber's trick: To lay your pipe at $\frac{1}{4}$ -inch per foot fall, do the following. At one end of a 4-foot level, tape a 1-inch high block. like this:

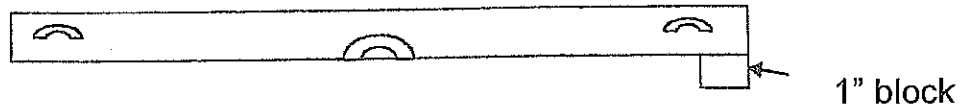

When the level is laid on the pipe and the bubble indicates level, your pipe is falling at $\frac{1}{4}$ -inch per foot:



3. Size the pit to hold at least twice as much water as will be sent to the pit at any given time. Example: You are building a dry well for the water from your washing machine. You typically wash two loads at a time, creating about 70 gallons of waste water. Your dry well should be large enough to contain at least 140 gallons.
4. Place the tires in the pit. [See dry well illustration on the following page]
5. The horizontal tires on each end of the pit should be filled with compacted soil. Make sure the horizontal tires at the end of the pit where the pipe enters are well-compacted. If they settle, the pipe will be broken.
6. Create a vent.
7. Carefully cover all of the tires with sheathing, old cardboard, or an old piece of carpet. Make sure the covering goes all the way to the bottom of the pit on all sides of the tires. [Dry well illustration #9] This covering keeps the soil from filling the void created by the tires.
8. Cover the tires and sheathing in the pit with soil. Compact the soil gently. Leave a mound over the tank. It will settle over time.
9. Place markers or a fence around the dry well so that it will not be driven over. You can walk over it with no problems.

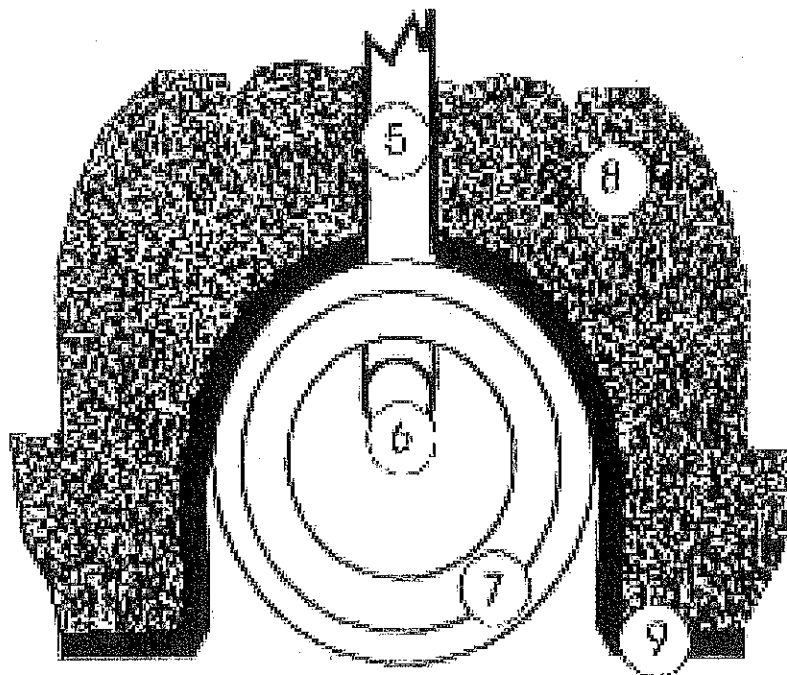
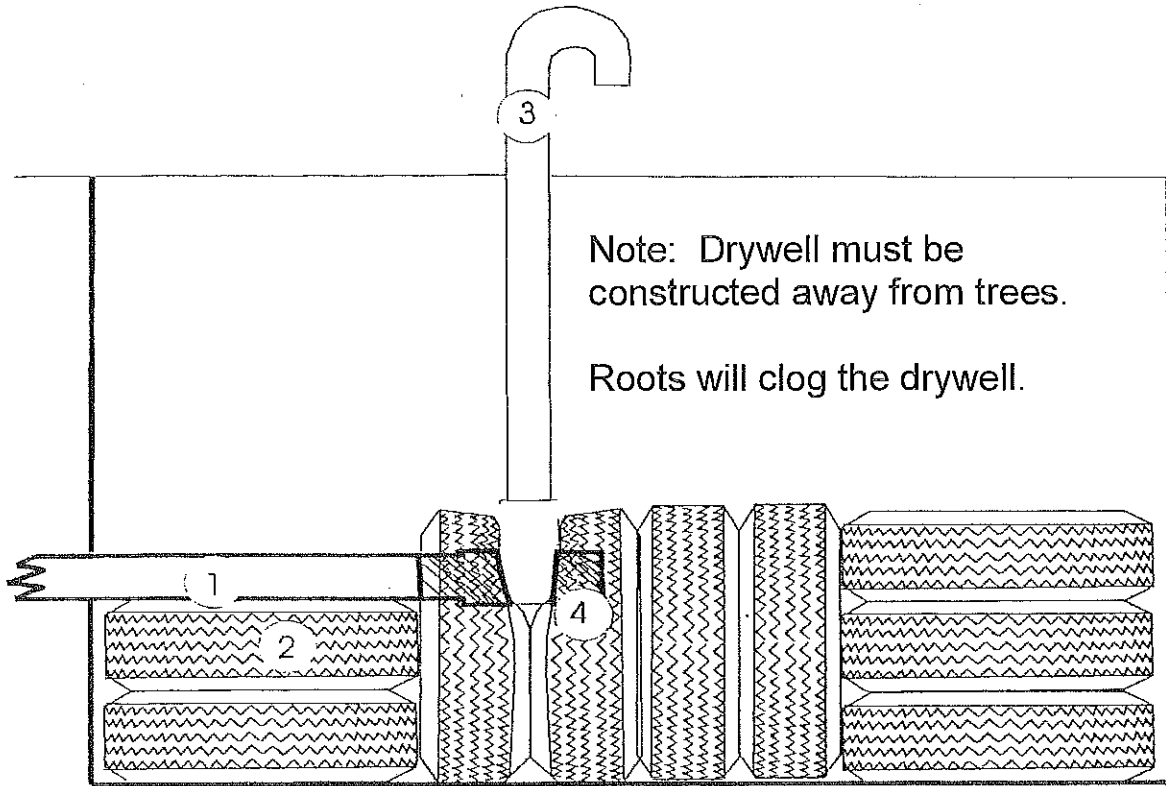

1. Source of wastewater
2. Tires compacted with soil (vertical tires are not filled with soil)
3. Vent pipe
4. "T" section
5. Vent pipe
6. "T" section
7. Tire
8. Soil
9. Old carpet, etc.